

Application

The fan is intended for all types of general ventilation installations.

Typical applications are:

- general ventilation systems of commercial and industrial premises,
- ventilation of storage facilities
- ventilation of garages, public utility buildings, etc.

Construction

- impeller is made of glass-fibre reinforced polypropylene, aluminium hub,
- impeller is dynamically balanced in accordance with ISO 21940-11: 2016,
- welded steel sheet housing,
- bolted steel motor plate,
- flow direction impeller -> motor,
- fan painted black RAL 9005,
- inspection cover on the housing,
- installation in a horizontal or vertical position.

Electric motor

- asynchronous, single-phase 230V 50Hz,
- asynchronous, three-phase 230/400V 50Hz, 400/690V 50Hz,
- degree of protection IP 55, insulation class F,
- for voltage regulation (single-phase motors),
- for frequency control (three-phase motors).

On request

- aluminium impeller,
- painting in a color other than the standard,
- painting in a higher corrosivity category,
- galvanized steel sheet housing,
- housing made of stainless steel 1.4301,
- housing made of acid-proof steel 1.4404,
- motor for other than standard voltage and power frequency,
- motor with a different degree of protection,
- motor with a different insulation class,
- motor equipped with sensors or additional cooling,
- fan with a diameter of more than 1250 mm.

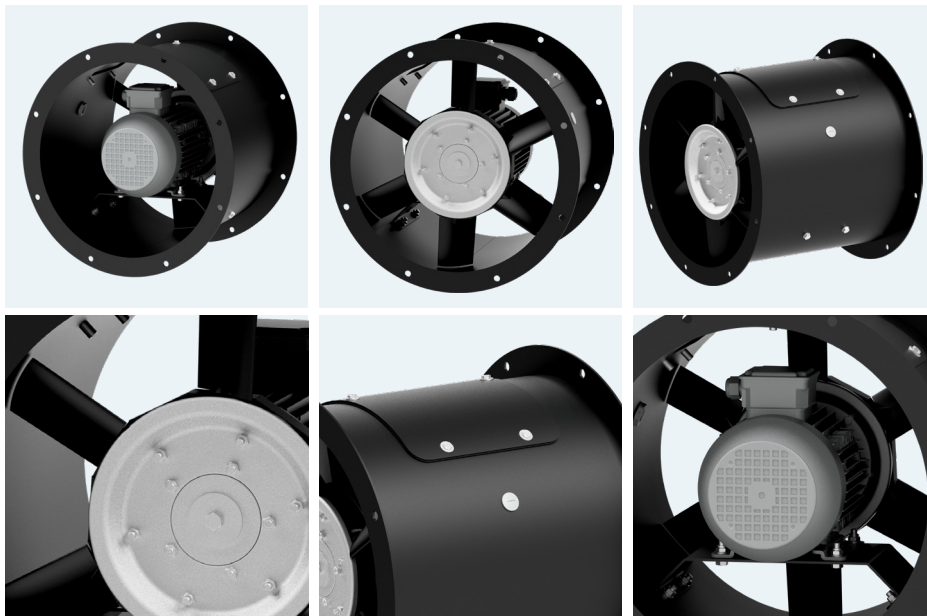

RELATED PRODUCTS

AFC-EC
EC motor version

AFC-HT
High temperature version

AFC-VB
Belt drive

AFD
Wall version

AFH
Motor out of air flow

ARC
Reversion mode

EAC
Atex version



NOMINAL DATA

type	airflow max	pressure max	speed	voltage rated	current max absorbed**	motor power	sound pressure level*	weight	article number
SINGLE-PHASE, DOUBLE-POLE MOTORS									
AFC-402-075S	5 800 m ³ /h	480 Pa	2 880 rpm	1-230 V	4,2 A	0,75 kW	76 dB(A)	26,0 kg	430402071
AFC-402-110S	7 000 m ³ /h	490 Pa	2 900 rpm	1-230 V	5,8 A	1,1 kW	73 dB(A)	27,0 kg	430402111
AFC-452-110S	7 000 m ³ /h	550 Pa	2 900 rpm	1-230 V	5,8 A	1,1 kW	77 dB(A)	28,0 kg	430452111
THREE-PHASE, DOUBLE-POLE MOTORS									
AFC-402-075T	5 800 m ³ /h	480 Pa	2 890 rpm	3-400 V	1,7 A	0,75 kW	76 dB(A)	26,0 kg	430402073
AFC-402-110T	7 000 m ³ /h	490 Pa	2 890 rpm	3-400 V	2,5 A	1,1 kW	73 dB(A)	27,0 kg	430402113
AFC-402-150T	8 450 m ³ /h	485 Pa	2 880 rpm	3-400 V	3,0 A	1,5 kW	72 dB(A)	32,0 kg	430402153
AFC-402-220T	9 300 m ³ /h	495 Pa	2 885 rpm	3-400 V	4,6 A	2,2 kW	73 dB(A)	35,0 kg	430402223
AFC-402-300T	10 500 m ³ /h	495 Pa	2 870 rpm	3-400 V	6,3 A	3,0 kW	74 dB(A)	36,0 kg	430402303
AFC-452-110T	7 000 m ³ /h	550 Pa	2 890 rpm	3-400 V	2,5 A	1,1 kW	77 dB(A)	28,0 kg	430452113
AFC-452-150T	8 900 m ³ /h	525 Pa	2 880 rpm	3-400 V	3,0 A	1,5 kW	74 dB(A)	34,0 kg	430452153
AFC-452-220T	10 900 m ³ /h	520 Pa	2 885 rpm	3-400 V	4,6 A	2,2 kW	73 dB(A)	37,0 kg	430452223
AFC-452-300T	13 300 m ³ /h	520 Pa	2 870 rpm	3-400 V	6,3 A	3,0 kW	74 dB(A)	38,0 kg	430452303
AFC-452-400T	14 600 m ³ /h	510 Pa	2 895 rpm	3-400 V	7,4 A	4,0 kW	74 dB(A)	50,0 kg	430452403
AFC-502-220T	8 950 m ³ /h	600 Pa	2 885 rpm	3-400 V	4,6 A	2,2 kW	79 dB(A)	46,0 kg	430502223
AFC-502-300T	11 500 m ³ /h	650 Pa	2 870 rpm	3-400 V	6,3 A	3,0 kW	78 dB(A)	47,0 kg	430502303
AFC-502-400T	14 200 m ³ /h	690 Pa	2 895 rpm	3-400 V	7,4 A	4,0 kW	76 dB(A)	61,0 kg	430502403
AFC-502-550T	16 600 m ³ /h	690 Pa	2 890 rpm	3-400 V	9,8 A	5,5 kW	77 dB(A)	71,0 kg	430502553
AFC-502-750T	19 300 m ³ /h	640 Pa	2 885 rpm	3-400 V	14,0 A	7,5 kW	78 dB(A)	72,0 kg	430502554
AFC-562-300T	13 700 m ³ /h	840 Pa	2 870 rpm	3-400 V	6,3 A	3,0 kW	83 dB(A)	49,0 kg	430562303
AFC-562-400T	16 900 m ³ /h	860 Pa	2 895 rpm	3-400 V	7,4 A	4,0 kW	81 dB(A)	67,0 kg	430562403
AFC-562-550T	21 100 m ³ /h	920 Pa	2 890 rpm	3-400 V	9,8 A	5,5 kW	80 dB(A)	75,0 kg	430562553
AFC-562-750T	24 000 m ³ /h	940 Pa	2 885 rpm	3-400 V	14,0 A	7,5 kW	80 dB(A)	75,0 kg	430562753
AFC-562-1100T	27 700 m ³ /h	950 Pa	2 900 rpm	3-400 V	19,1 A	11,0 kW	81 dB(A)	99,0 kg	430562813
AFC-632-400T	15 800 m ³ /h	830 Pa	2 895 rpm	3-400 V	7,4 A	4,0 kW	96 dB(A)	73,0 kg	430632403
AFC-632-550T	20 700 m ³ /h	930 Pa	2 890 rpm	3-400 V	9,8 A	5,5 kW	88 dB(A)	84,0 kg	430632553
AFC-632-750T	25 500 m ³ /h	1000 Pa	2 885 rpm	3-400 V	14,0 A	7,5 kW	84 dB(A)	84,0 kg	430632753
AFC-632-1100T	31 200 m ³ /h	1020 Pa	2 900 rpm	3-400 V	19,1 A	11,0 kW	83 dB(A)	102,0 kg	430632813

* Measurement made at a distance of 1.5m from the outlet, for Q = 2/3 * Qmax
 ** value of the rated current may vary depending on the manufacturer of the electric motor used.



NOMINAL DATA

type	airflow max	pressure max	speed	voltage rated	current max absorbed**	motor power	sound pressure level*	weight	article number
AFC-632-1500T	37 600 m ³ /h	970 Pa	2 940 rpm	3~400 V	26,2	15,0 kW	85 dB(A)	142,0 kg	430632853
THREE-PHASE, FOUR-POLE MOTORS									
AFC-564-037T	6 850 m ³ /h	230 Pa	1 410 rpm	3~400 V	1,1 A	0,37 kW	68 dB(A)	36,0 kg	430564033
AFC-564-055T	8 450 m ³ /h	235 Pa	1 420 rpm	3~400 V	1,6 A	0,55 kW	66 dB(A)	38,0 kg	430564053
AFC-564-075T	10 500 m ³ /h	250 Pa	1 430 rpm	3~400 V	2,1 A	0,75 kW	66 dB(A)	40,0 kg	430564073
AFC-564-110T	12 000 m ³ /h	250 Pa	1 425 rpm	3~400 V	2,5 A	1,1 kW	65 dB(A)	48,0 kg	430564113
AFC-564-150T	13 900 m ³ /h	240 Pa	1 440 rpm	3~400 V	3,6 A	1,5 kW	66 dB(A)	49,0 kg	430564153
AFC-634-055T	7 900 m ³ /h	245 Pa	1 420 rpm	3~400 V	1,6 A	0,55 kW	79 dB(A)	45,0 kg	430634053
AFC-634-075T	10 300 m ³ /h	265 Pa	1 430 rpm	3~400 V	2,1 A	0,75 kW	73 dB(A)	47,0 kg	430634073
AFC-634-110T	12 800 m ³ /h	250 Pa	1 425 rpm	3~400 V	2,5 A	1,1 kW	69 dB(A)	47,0 kg	430634113
AFC-634-150T	15 600 m ³ /h	260 Pa	1 440 rpm	3~400 V	3,6 A	1,5 kW	68 dB(A)	57,0 kg	430634153
AFC-634-220T	18 800 m ³ /h	245 Pa	1 450 rpm	3~400 V	4,6 A	2,2 kW	70 dB(A)	73,0 kg	430634223
AFC-714-110T	12 900 m ³ /h	370 Pa	1 425 rpm	3~400 V	2,5 A	1,1 kW	77 dB(A)	61,0 kg	430714113
AFC-714-150T	15 400 m ³ /h	380 Pa	1 440 rpm	3~400 V	3,6 A	1,5 kW	76 dB(A)	62,0 kg	430714153
AFC-714-220T	20 400 m ³ /h	390 Pa	1 450 rpm	3~400 V	4,6 A	2,2 kW	76 dB(A)	73,0 kg	430714223
AFC-714-300T	24 700 m ³ /h	375 Pa	1 460 rpm	3~400 V	6,7 A	3,0 kW	73 dB(A)	73,0 kg	430714303
AFC-714-400T	28 600 m ³ /h	325 Pa	1 450 rpm	3~400 V	8,4 A	4,0 kW	74 dB(A)	87,0 kg	430714403
AFC-804-150T	17 400 m ³ /h	430 Pa	1 440 rpm	3~400 V	3,6 A	1,5 kW	76 dB(A)	74,0 kg	430804153
AFC-804-220T	21 300 m ³ /h	480 Pa	1 450 rpm	3~400 V	4,6 A	2,2 kW	76 dB(A)	91,0 kg	430804223
AFC-804-300T	24 400 m ³ /h	520 Pa	1 460 rpm	3~400 V	6,7 A	3,0 kW	76 dB(A)	91,0 kg	430804303
AFC-804-400T	28 100 m ³ /h	530 Pa	1 450 rpm	3~400 V	8,4 A	4,0 kW	76 dB(A)	100,0 kg	430804403
AFC-804-550T	33 900 m ³ /h	440 Pa	1 460 rpm	3~400 V	10,8 A	5,5 kW	78 dB(A)	112,0 kg	430804553
AFC-904-300T	26 400 m ³ /h	600 Pa	1 460 rpm	3~400 V	6,7 A	3,0 kW	85 dB(A)	102,0 kg	430904303
AFC-904-400T	30 900 m ³ /h	600 Pa	1 450 rpm	3~400 V	8,4 A	4,0 kW	84 dB(A)	110,0 kg	430904403
AFC-904-550T	37 000 m ³ /h	600 Pa	1 460 rpm	3~400 V	10,8 A	5,5 kW	84 dB(A)	134,0 kg	430904553
AFC-904-750T	44 300 m ³ /h	605 Pa	1 450 rpm	3~400 V	14,6 A	7,5 kW	83 dB(A)	143,0 kg	430904753
AFC-904-1100T	55 300 m ³ /h	530 Pa	1 475 rpm	3~400 V	21,2 A	11,0 kW	82 dB(A)	176,0 kg	430904813
AFC-1004-550T	32 000 m ³ /h	920 Pa	1 460 rpm	3~400 V	10,8 A	5,5 kW	94 dB(A)	140,0 kg	431004553
AFC-1004-750T	42 100 m ³ /h	790 Pa	1 450 rpm	3~400 V	14,6 A	7,5 kW	93 dB(A)	149,0 kg	431004753
AFC-1004-1100T	52 200 m ³ /h	795 Pa	1 475 rpm	3~400 V	21,2 A	11,0 kW	91 dB(A)	197,0 kg	431004813
AFC-1004-1500T	61 500 m ³ /h	660 Pa	1 475 rpm	3~400 V	28,3 A	15,0 kW	89 dB(A)	208,0 kg	431004853
AFC-1004-1850T	68 500 m ³ /h	660 Pa	1 475 rpm	3~400 V	34,7 A	18,5 kW	88 dB(A)	223,0 kg	431004883
AFC-1124-1100T	57 800 m ³ /h	970 Pa	1 475 rpm	3~400 V	21,2 A	11,0 kW	92 dB(A)	251,0 kg	431124813
AFC-1124-1500T	70 200 m ³ /h	900 Pa	1 475 rpm	3~400 V	28,3 A	15,0 kW	89 dB(A)	262,0 kg	431124853
AFC-1124-1850T	80 200 m ³ /h	850 Pa	1 475 rpm	3~400 V	34,7 A	18,5 kW	87 dB(A)	277,0 kg	431124883
AFC-1124-2200T	87 600 m ³ /h	840 Pa	1 470 rpm	3~400 V	41,1 A	22,0 kW	87 dB(A)	295,0 kg	431124923
AFC-1124-3000T	105 000 m ³ /h	685 Pa	1 470 rpm	3~400 V	54,0 A	30,0 kW	86 dB(A)	470,0 kg	431124903
AFC-1254-1850T	67 000 m ³ /h	1330 Pa	1 475 rpm	3~400 V	34,7 A	18,5 kW	94 dB(A)	305,0 kg	431254883
AFC-1254-2200T	79 100 m ³ /h	1250 Pa	1 470 rpm	3~400 V	41,1 A	22,0 kW	93 dB(A)	323,0 kg	431254923
AFC-1254-3000T	99 300 m ³ /h	1130 Pa	1 470 rpm	3~400 V	54,0 A	30,0 kW	90 dB(A)	517,0 kg	431254903
AFC-1254-3700T	116 000 m ³ /h	1100 Pa	1 485 rpm	3~400 V	65,0 A	37,0 kW	90 dB(A)	620,0 kg	431254973
AFC-1254-4500T	127 000 m ³ /h	940 Pa	1 485 rpm	3~400 V	78,0 A	45,0 kW	89 dB(A)	657,0 kg	431254953

* Measurement made at a distance of 1.5m from the outlet, for Q = 2/3 * Qmax
 ** value of the rated current may vary depending on the manufacturer of the electric motor used.



PERFORMANCE CHARACTERISTICS OF THE FANS - Two-pole motors

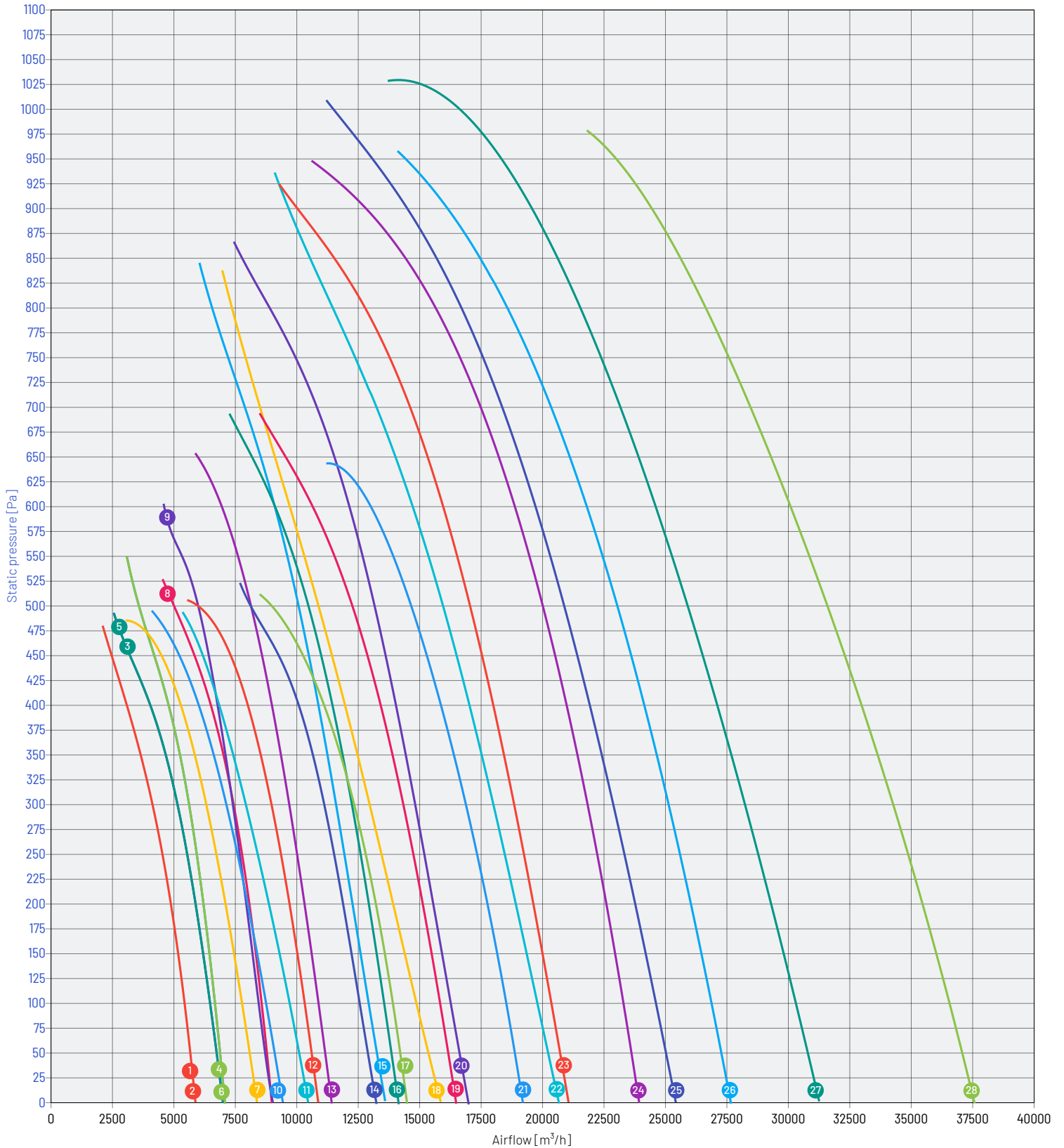

- 1 AFC-402-075S
- 2 AFC-402-075T
- 3 AFC-402-110S
- 4 AFC-452-110S
- 5 AFC-402-110T
- 6 AFC-452-110T
- 7 AFC-402-150T
- 8 AFC-452-150T
- 9 AFC-502-220T
- 10 AFC-402-220T
- 11 AFC-402-300T
- 12 AFC-452-220T
- 13 AFC-502-300T
- 14 AFC-452-300T
- 15 AFC-562-300T
- 16 AFC-502-400T
- 17 AFC-452-400T
- 18 AFC-632-400T
- 19 AFC-502-550T
- 20 AFC-562-400T
- 21 AFC-502-750T
- 22 AFC-632-550T
- 23 AFC-562-550T
- 24 AFC-562-750T
- 25 AFC-632-750T
- 26 AFC-562-1100T
- 27 AFC-632-1100T
- 28 AFC-632-1500T



PERFORMANCE CHARACTERISTICS OF THE FANS - Four-pole motors

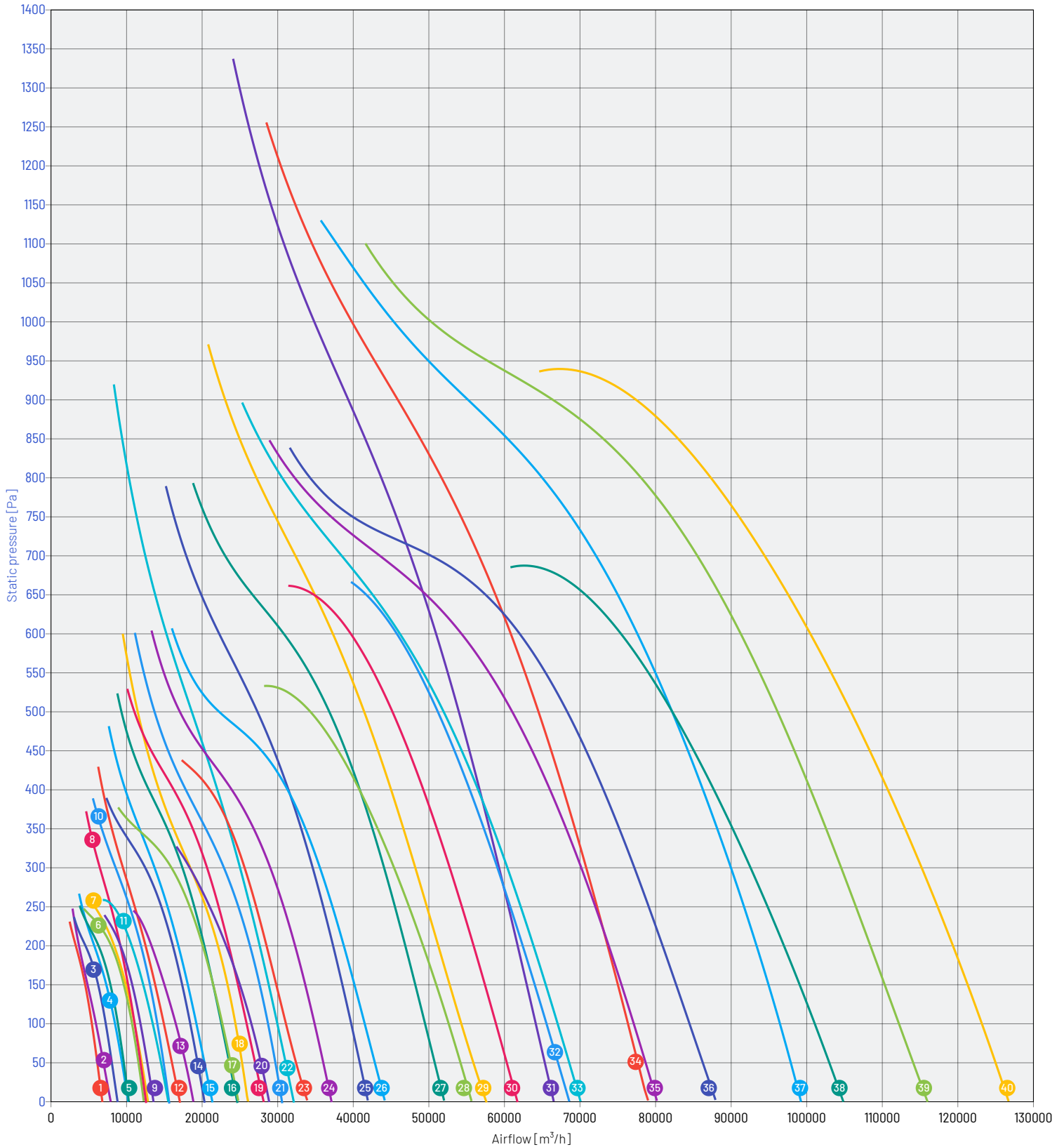

- 1 AFC-564-037T
- 2 AFC-634-055T
- 3 AFC-564-055T
- 4 AFC-634-075T
- 5 AFC-564-075T
- 6 AFC-564-110T
- 7 AFC-634-110T
- 8 AFC-714-110T
- 9 AFC-564-150T
- 10 AFC-714-150T
- 11 AFC-634-150T
- 12 AFC-804-150T
- 13 AFC-634-220T
- 14 AFC-714-220T
- 15 AFC-804-220T
- 16 AFC-804-300T
- 17 AFC-714-300T
- 18 AFC-904-300T
- 19 AFC-804-400T
- 20 AFC-714-400T
- 21 AFC-904-400T
- 22 AFC-1004-550T
- 23 AFC-804-550T
- 24 AFC-904-550T
- 25 AFC-1004-750T
- 26 AFC-904-750T
- 27 AFC-1004-1100T
- 28 AFC-904-1100T
- 29 AFC-1124-1100T
- 30 AFC-1004-1500T
- 31 AFC-1254-1850T
- 32 AFC-1004-1850T
- 33 AFC-1124-1500T
- 34 AFC-1254-2200T
- 35 AFC-1124-1850T
- 36 AFC-1124-2200T
- 37 AFC-1254-3000T
- 38 AFC-1124-3000T
- 39 AFC-1254-3700T
- 40 AFC-1254-4500T



PERFORMANCE CHARACTERISTICS OF THE FANS

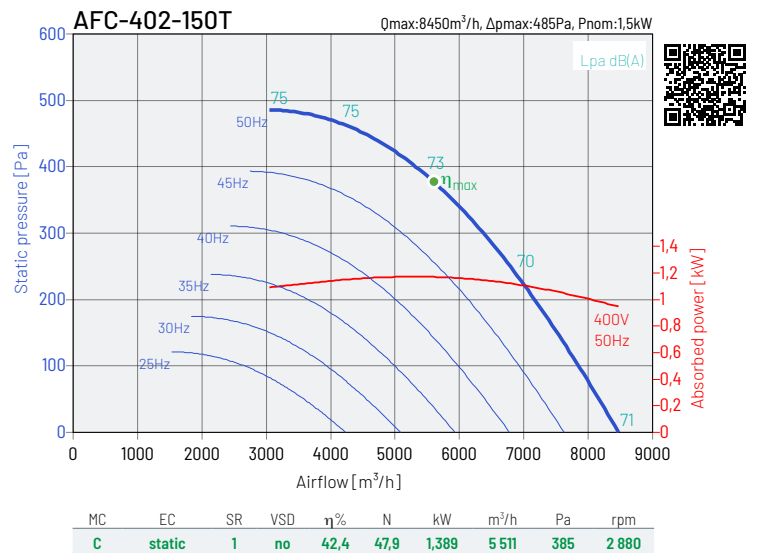
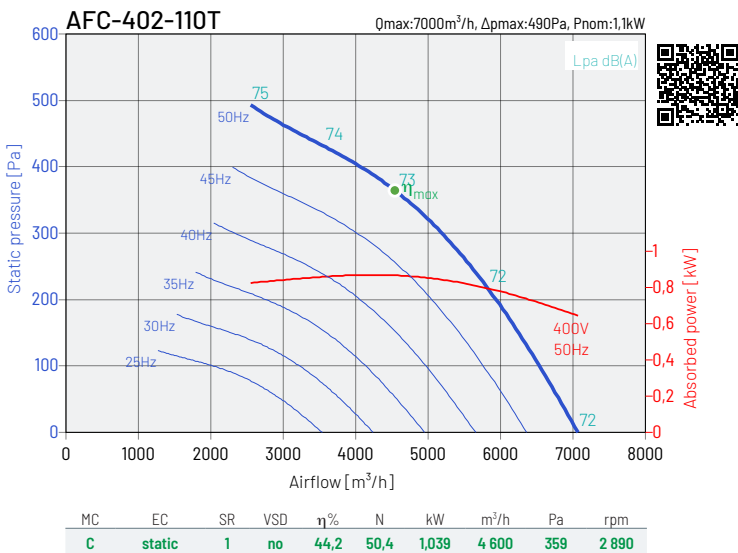
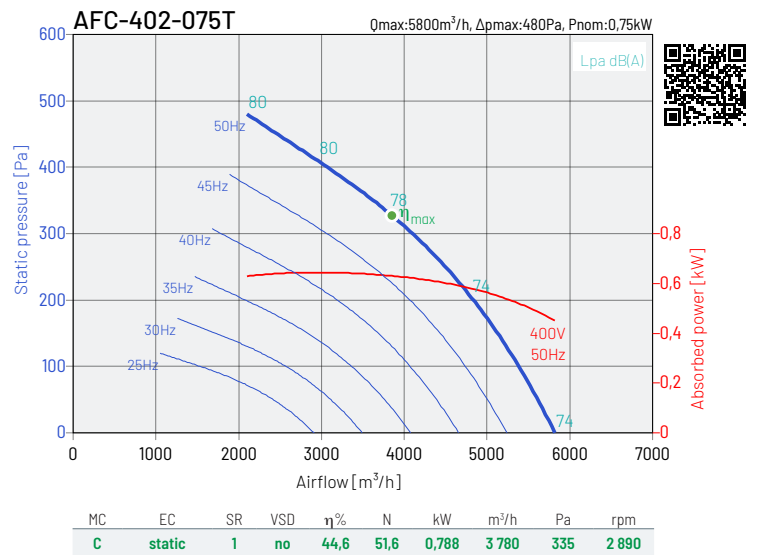
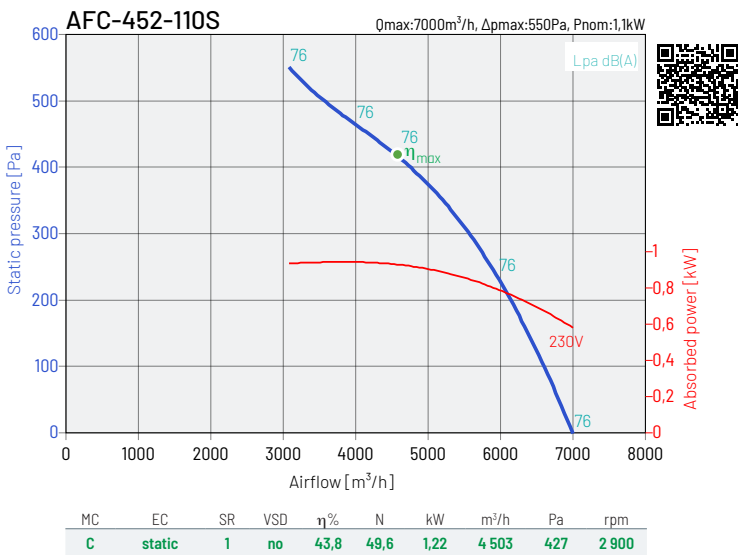
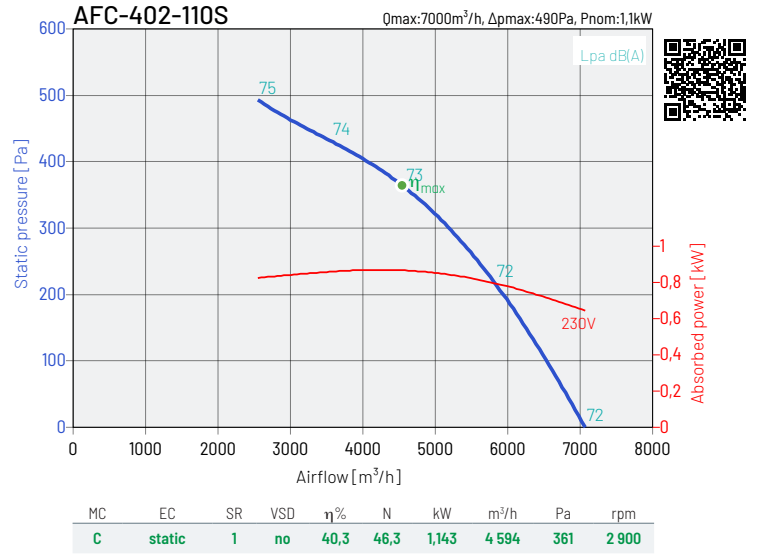
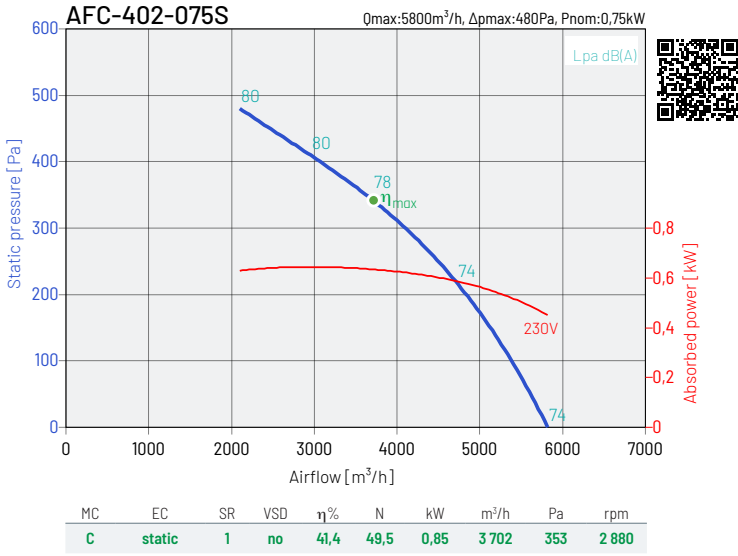

The performance characteristics of the fans are determined for a medium with a temperature of 20°C and atmospheric pressure of 1013.25hPa. Sound pressure level dB(A), determined at a distance of 1,5 m
 EcoProject: MC-Measurement category, EC-Efficiency category, VSD-Speed control: supplied with the fan, SR-Specific ratio, η%-Efficiency, N-Efficiency grade, kW-Absorbed power, m³/h-Airflow, Pa-Static pressure, RPM-Speed



PERFORMANCE CHARACTERISTICS OF THE FANS

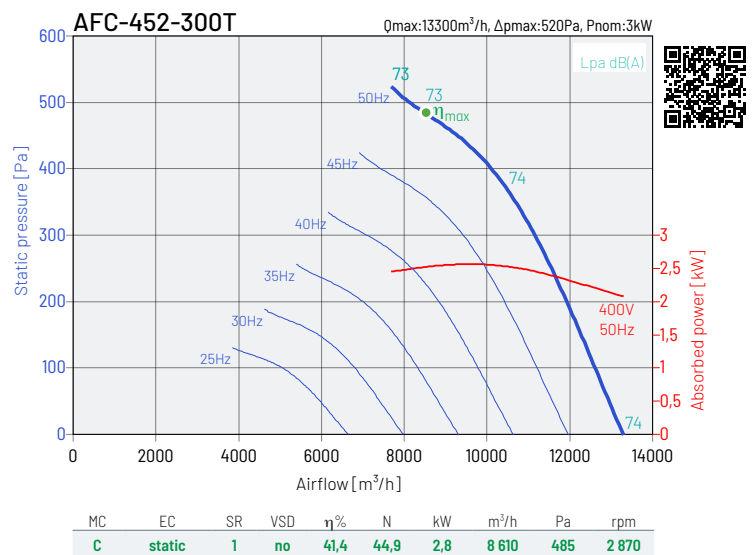
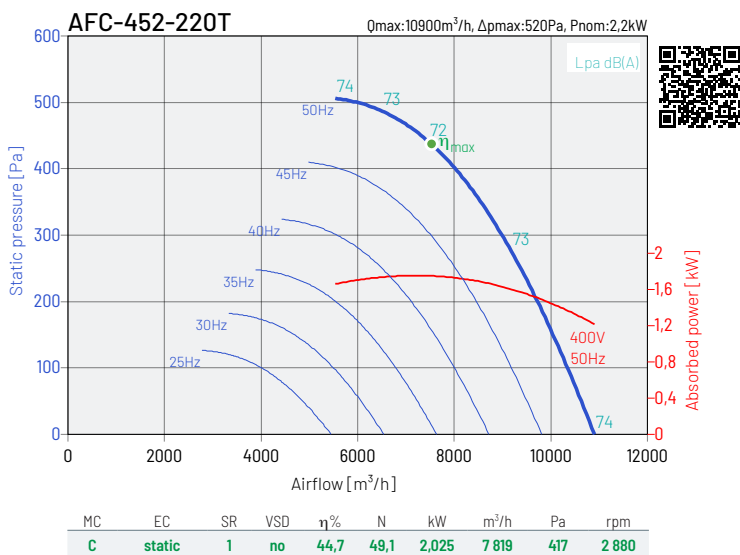
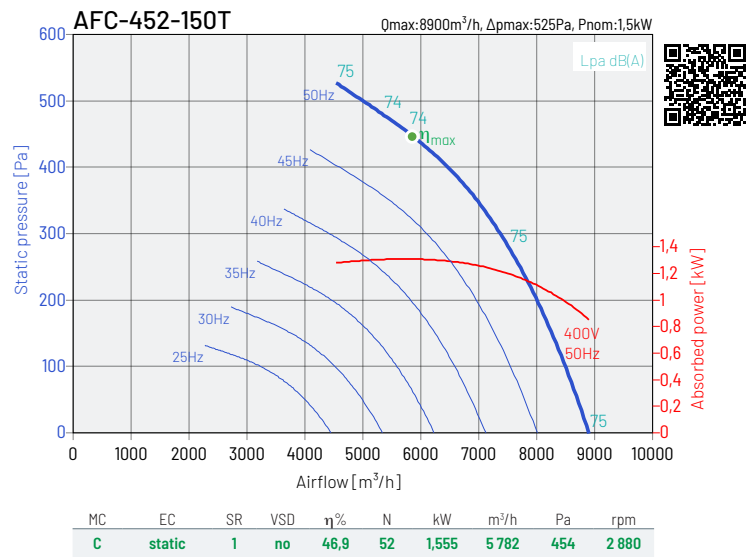
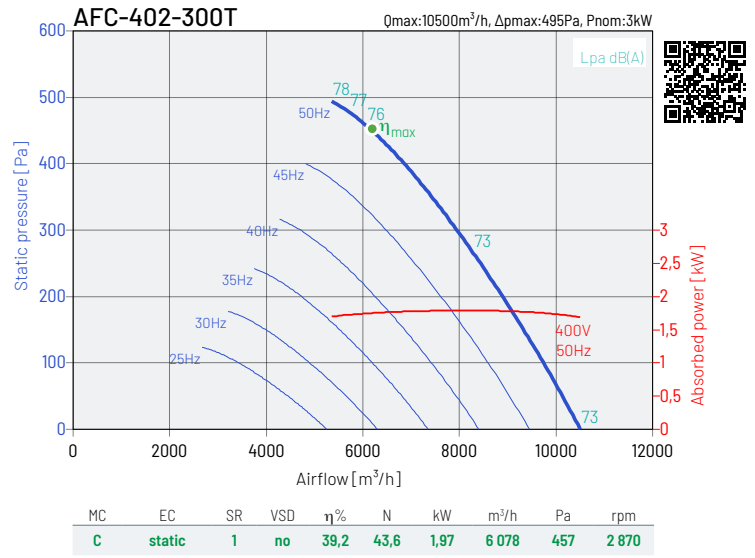

The performance characteristics of the fans are determined for a medium with a temperature of 20°C and atmospheric pressure of 1013.25hPa. Sound pressure level dB(A), determined at a distance of 1,5 m
Ecoproject: MC-Measurement category, EC-Efficiency category, VSD-Speed control: supplied with the fan, SR-Specific ratio, $\eta\%$ -Efficiency, N-Efficiency grade, kW-Absorbed power, m³/h-Airflow, Pa-Static pressure, RPM-Speed



PERFORMANCE CHARACTERISTICS OF THE FANS

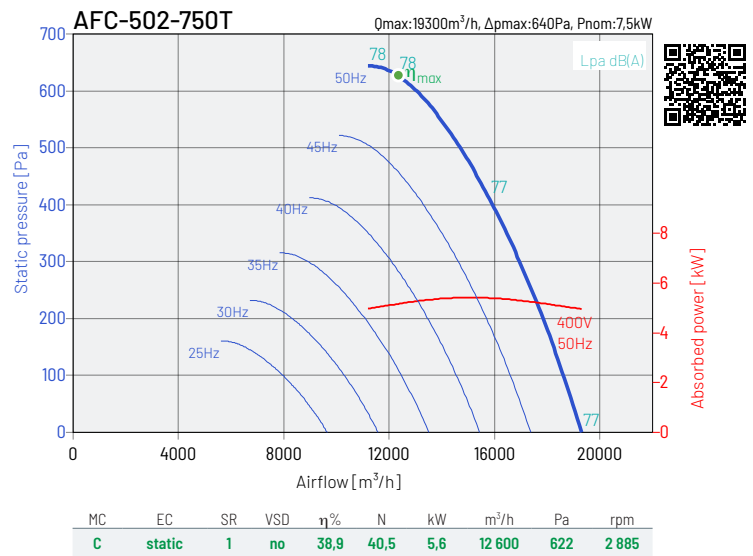
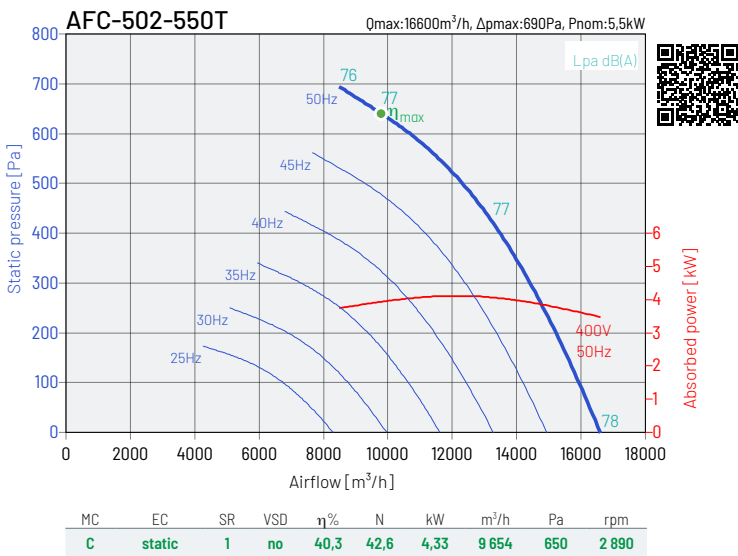
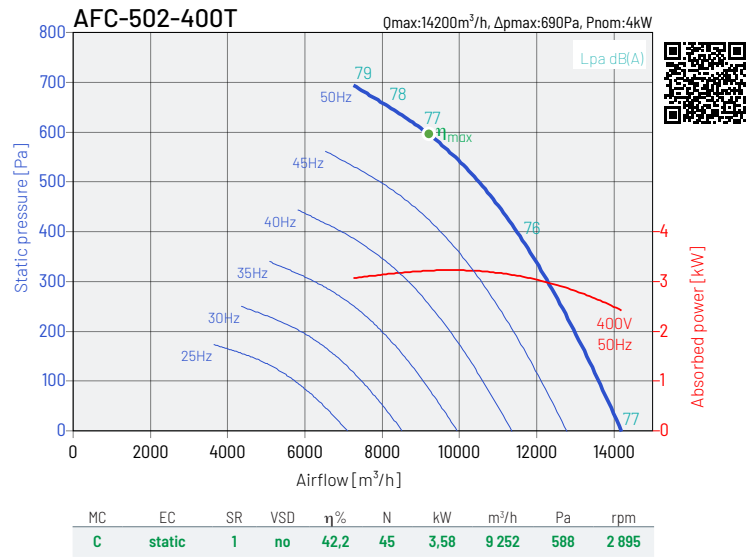
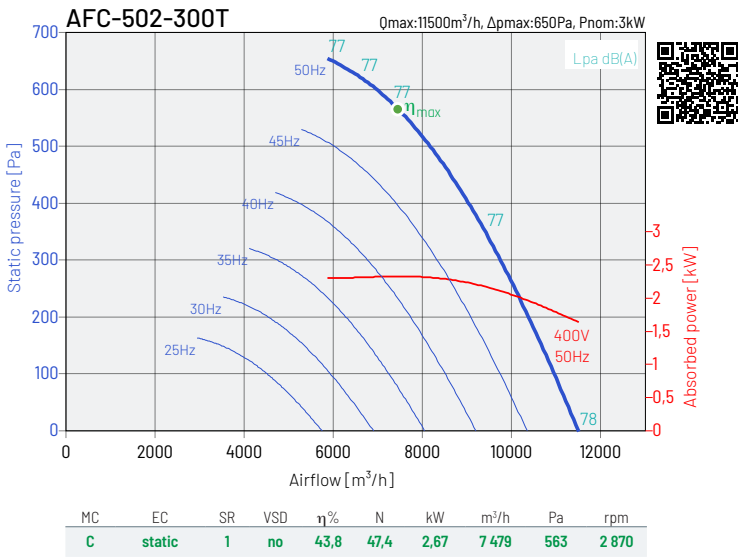
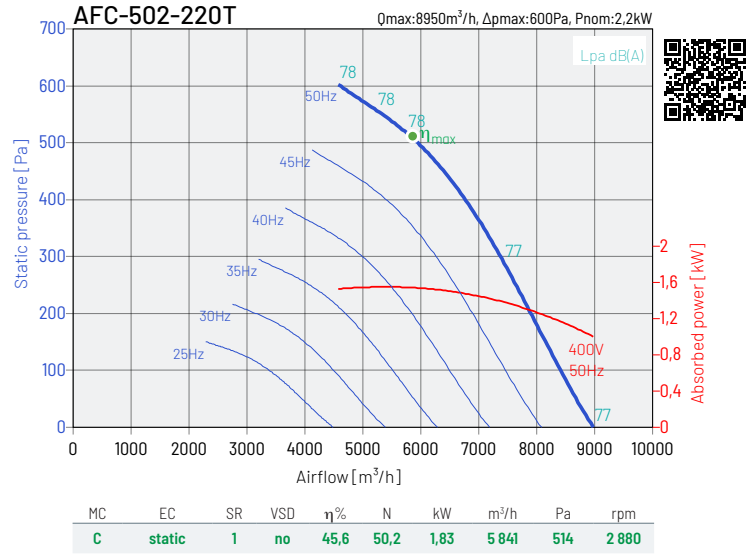
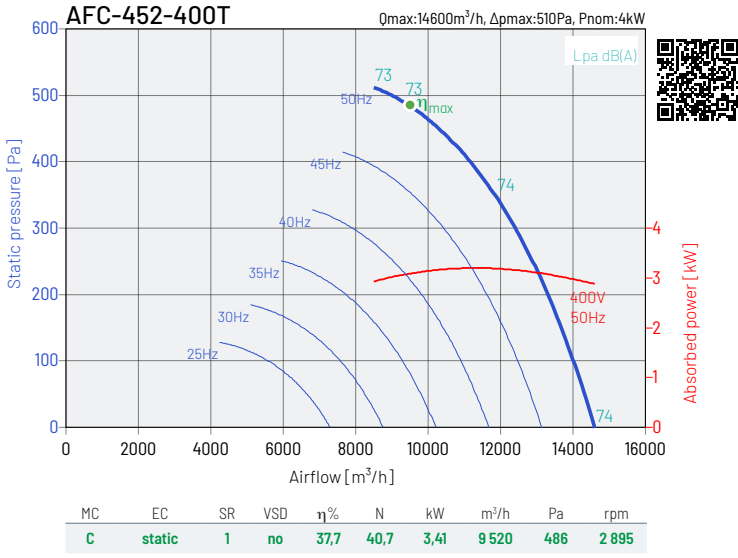

The performance characteristics of the fans are determined for a medium with a temperature of 20°C and atmospheric pressure of 1013.25hPa. Sound pressure level dB(A), determined at a distance of 1,5 m
Ecoproject: MC-Measurement category, EC-Efficiency category, VSD-Speed control: supplied with the fan, SR-Specific ratio, η%-Efficiency, N-Efficiency grade, kW-Absorbed power, m³/h-Airflow, Pa-Static pressure, RPM-Speed



PERFORMANCE CHARACTERISTICS OF THE FANS

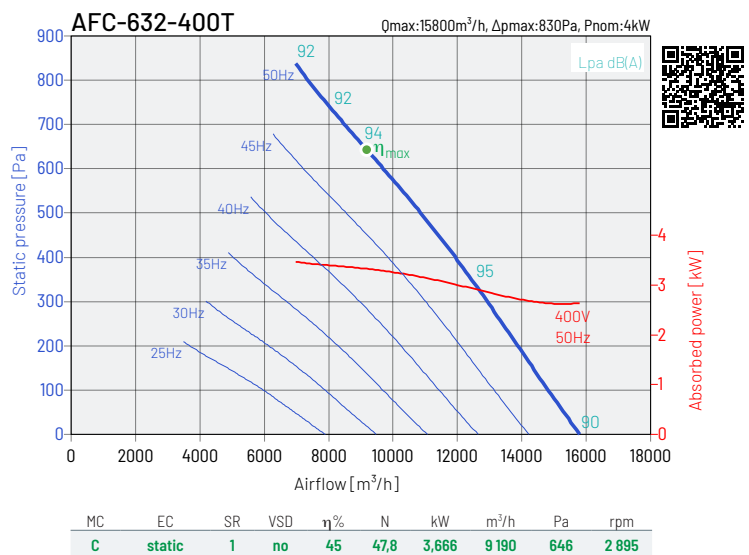
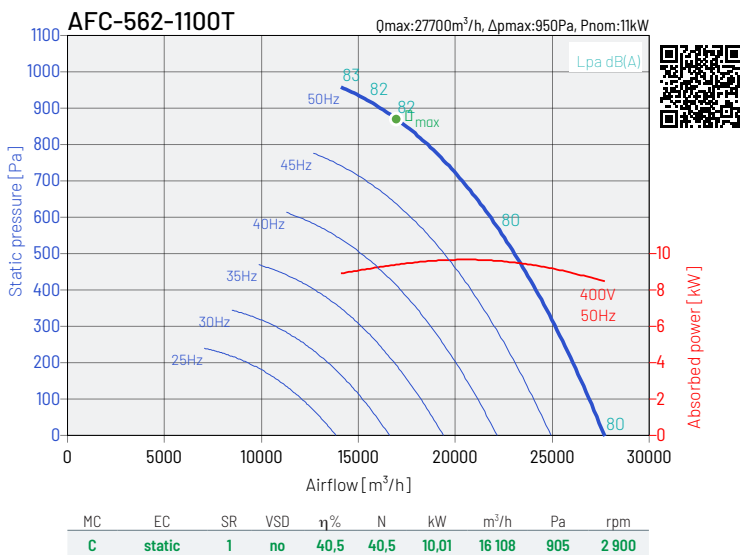
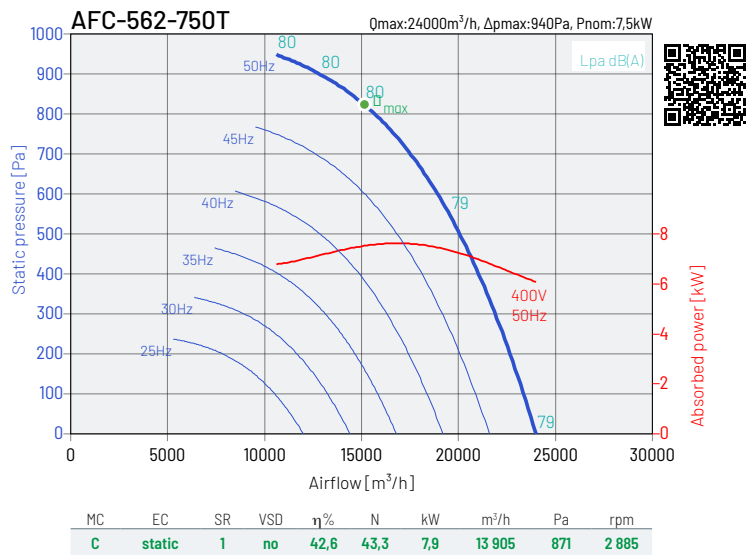
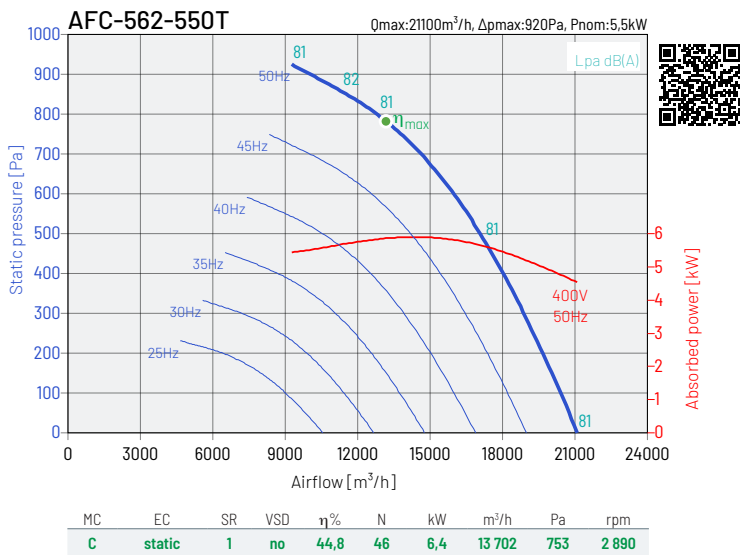
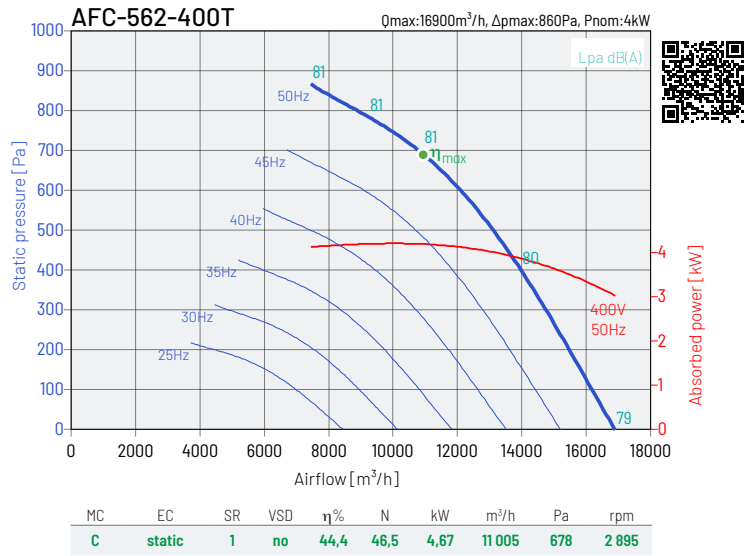
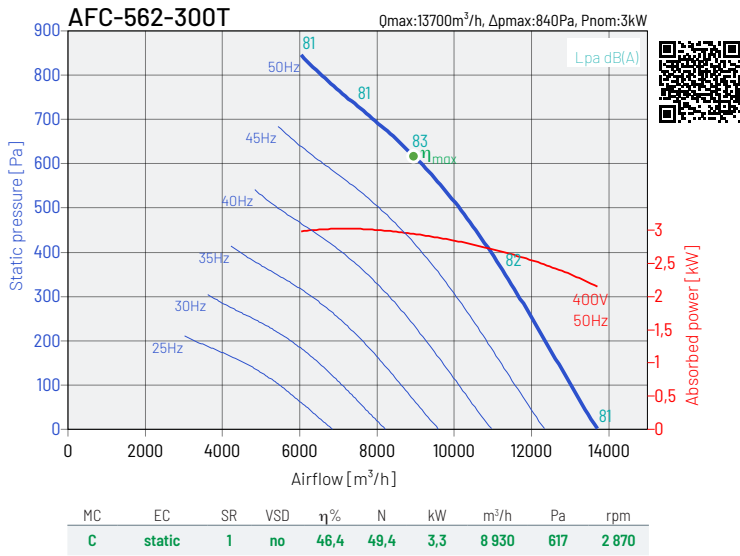

The performance characteristics of the fans are determined for a medium with a temperature of 20°C and atmospheric pressure of 1013.25hPa. Sound pressure level dB(A), determined at a distance of 1,5 m
Ecoproject: MC-Measurement category, EC-Efficiency category, VSD-Speed control: supplied with the fan, SR-Specific ratio, η%-Efficiency, N-Efficiency grade, kW-Absorbed power, m³/h-Airflow, Pa-Static pressure, RPM-Speed



PERFORMANCE CHARACTERISTICS OF THE FANS

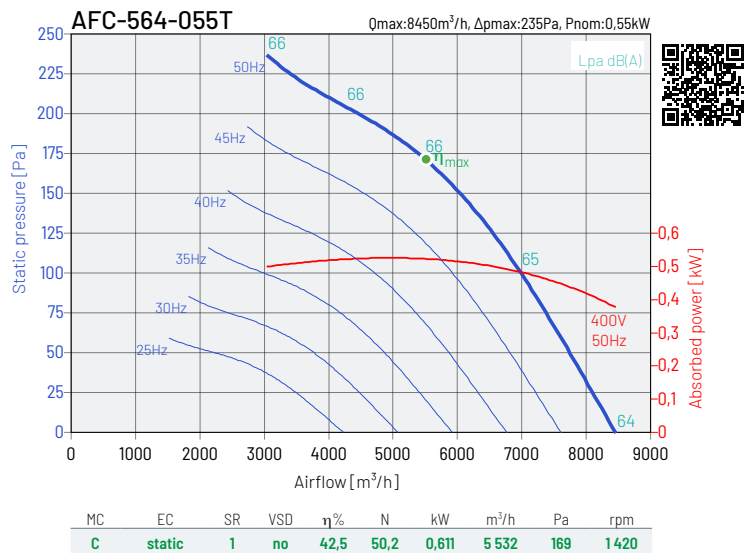
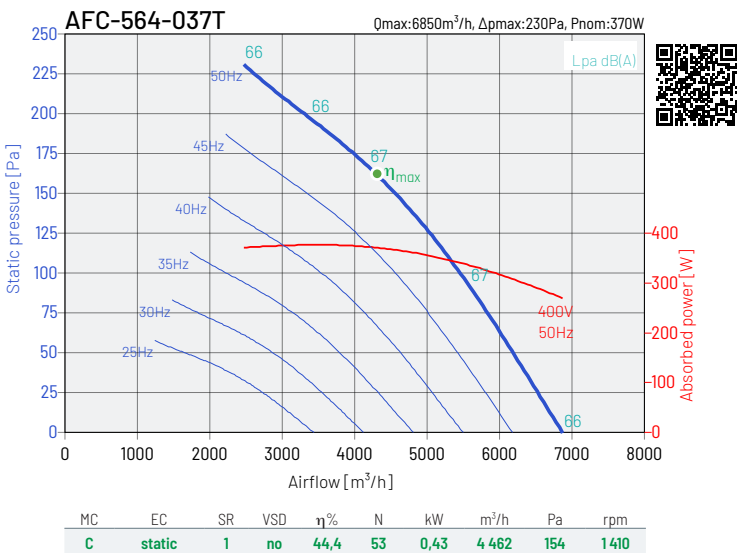
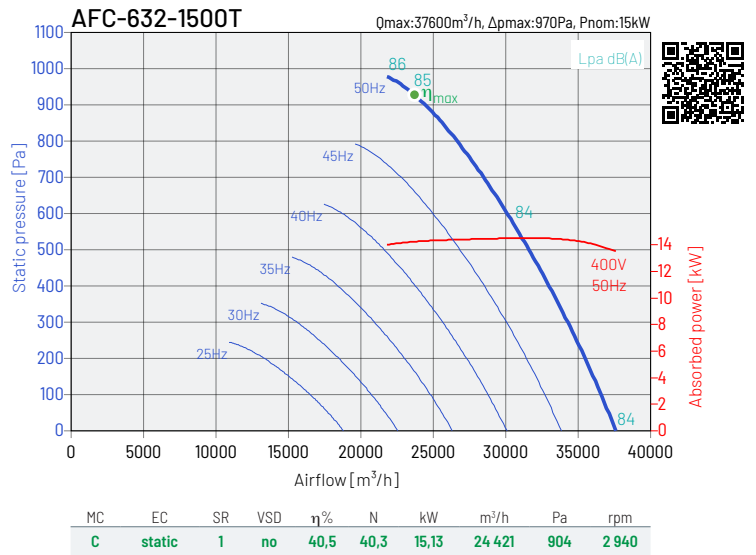
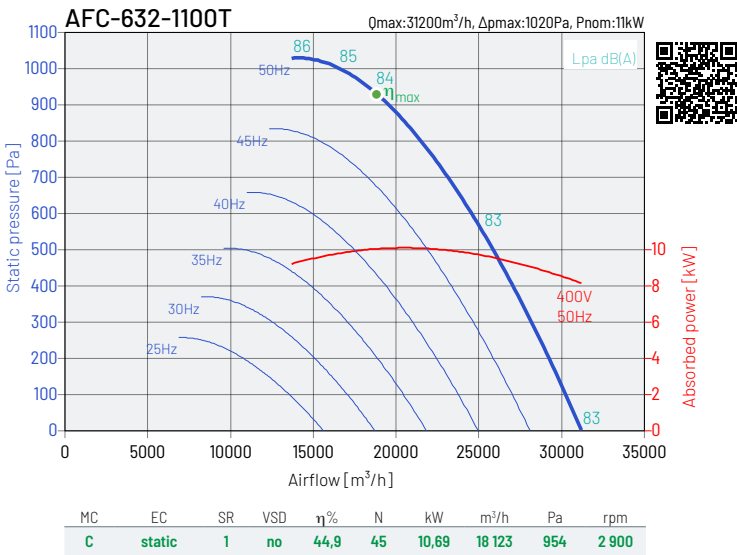
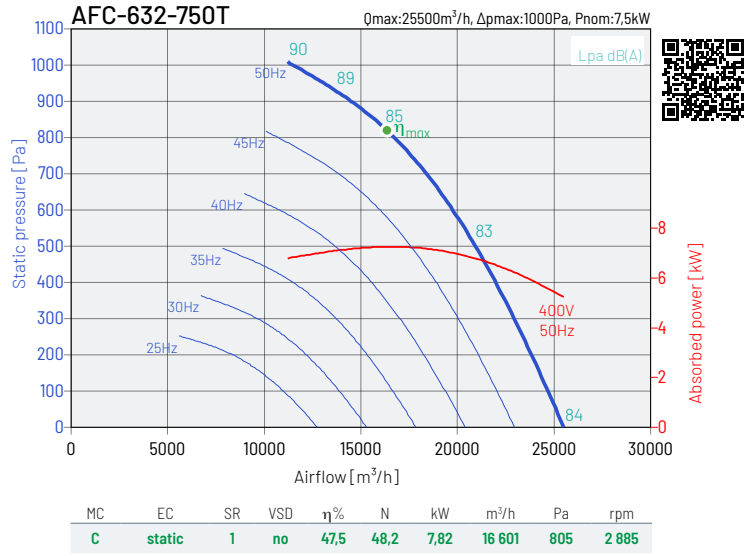
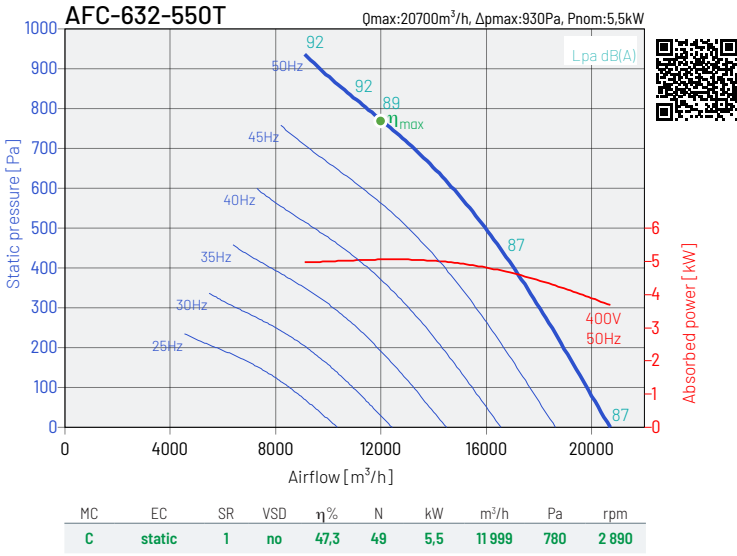

The performance characteristics of the fans are determined for a medium with a temperature of 20°C and atmospheric pressure of 1013.25hPa. Sound pressure level dB(A), determined at a distance of 1,5 m
Ecoproject: MC-Measurement category, EC-Efficiency category, VSD-Speed control: supplied with the fan, SR-Specific ratio, η%-Efficiency, N-Efficiency grade, kW-Absorbed power, m³/h-Airflow, Pa-Static pressure, RPM-Speed



PERFORMANCE CHARACTERISTICS OF THE FANS

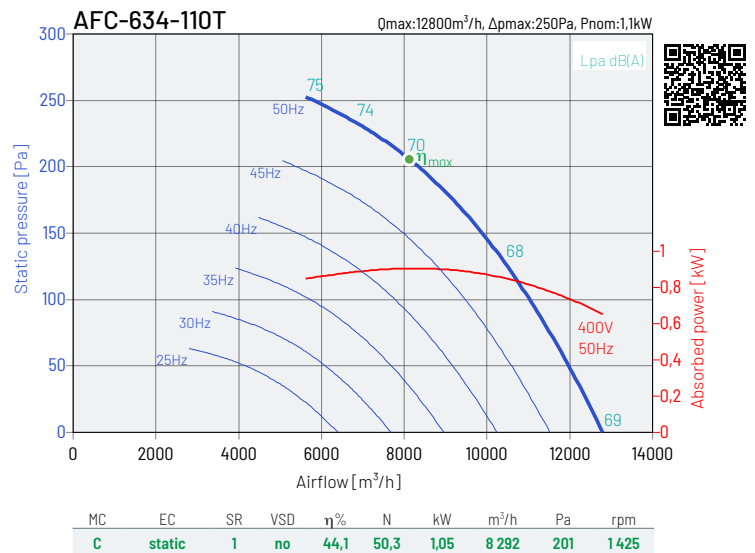
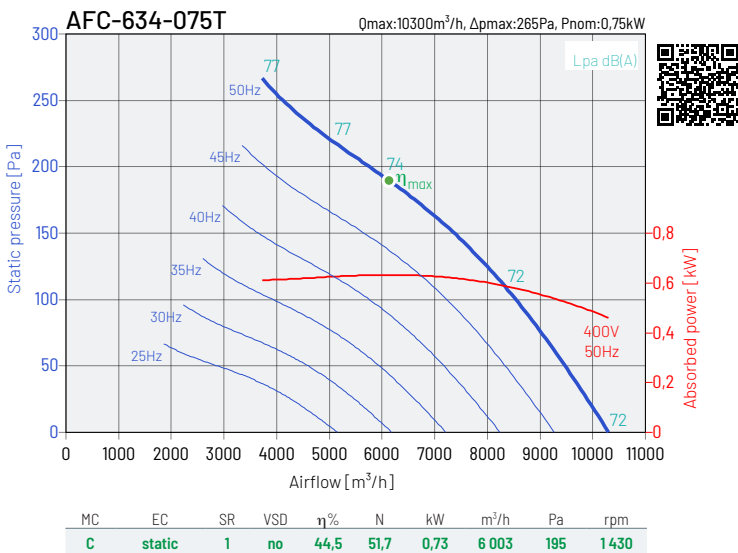
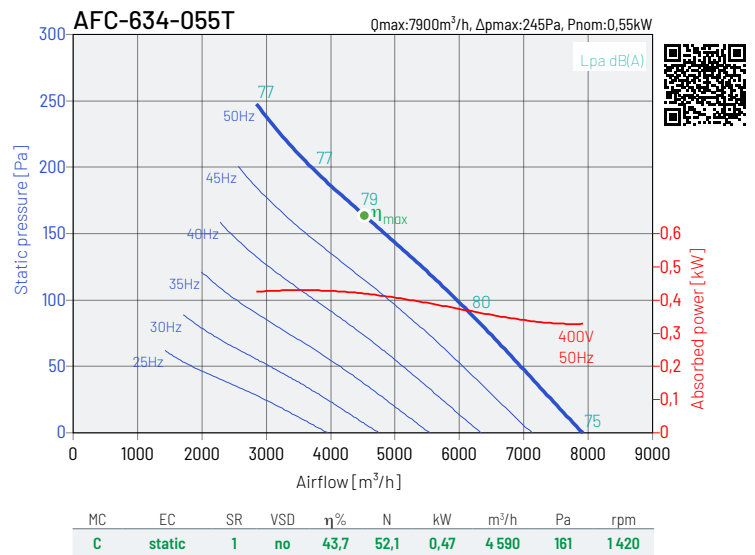
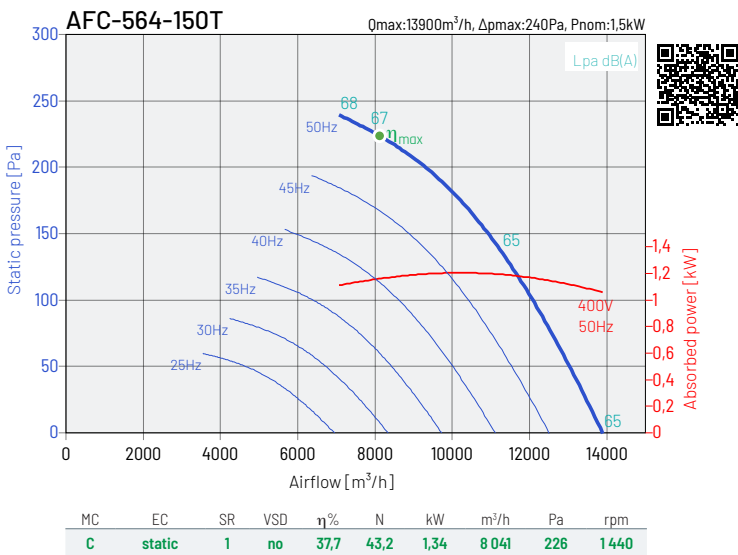
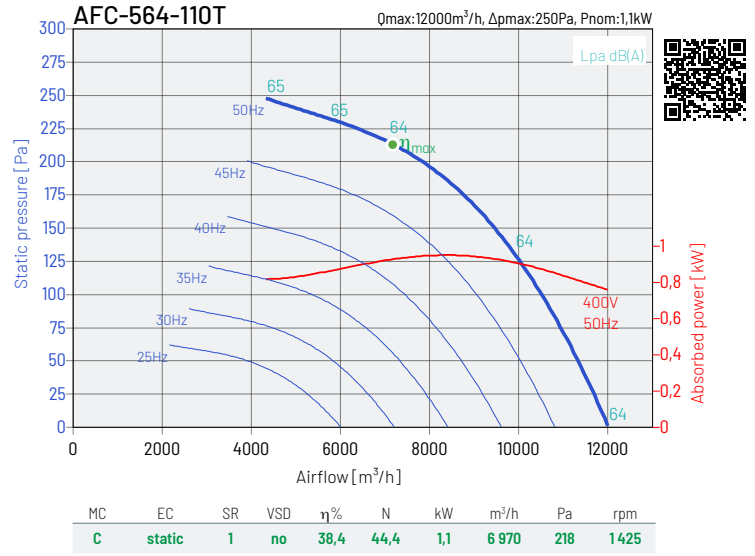
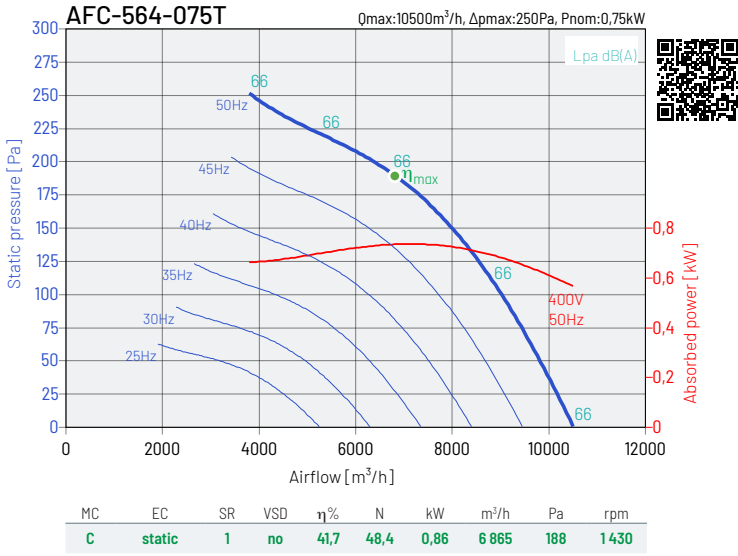

The performance characteristics of the fans are determined for a medium with a temperature of 20°C and atmospheric pressure of 1013.25hPa. Sound pressure level dB(A), determined at a distance of 1,5 m
 EcoProject: MC-Measurement category, EC-Efficiency category, VSD-Speed control: supplied with the fan, SR-Specific ratio, η%-Efficiency, N-Efficiency grade, kW-Absorbed power, m³/h-Airflow, Pa-Static pressure, RPM-Speed



PERFORMANCE CHARACTERISTICS OF THE FANS

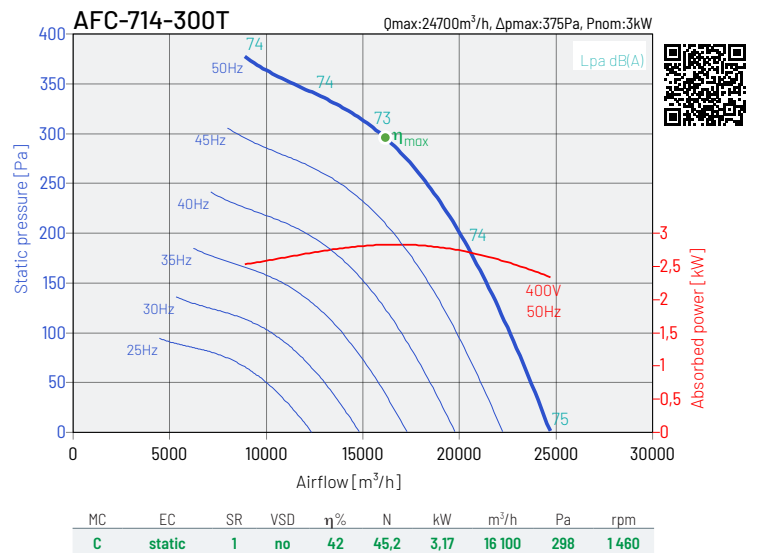
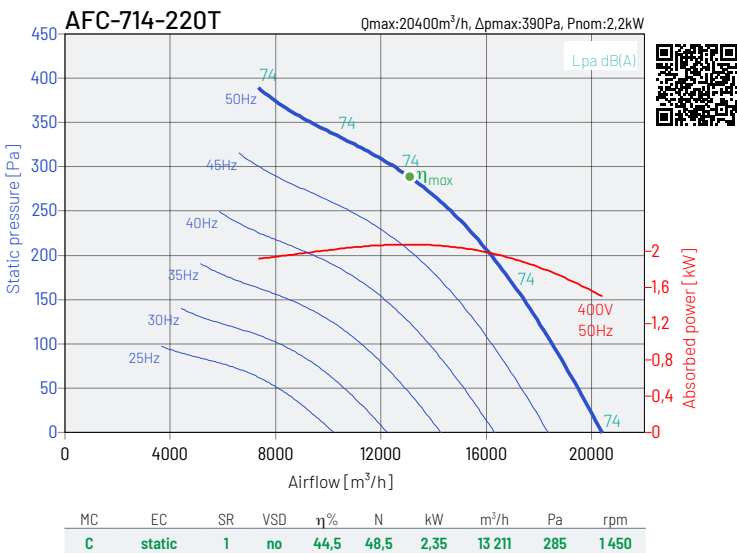
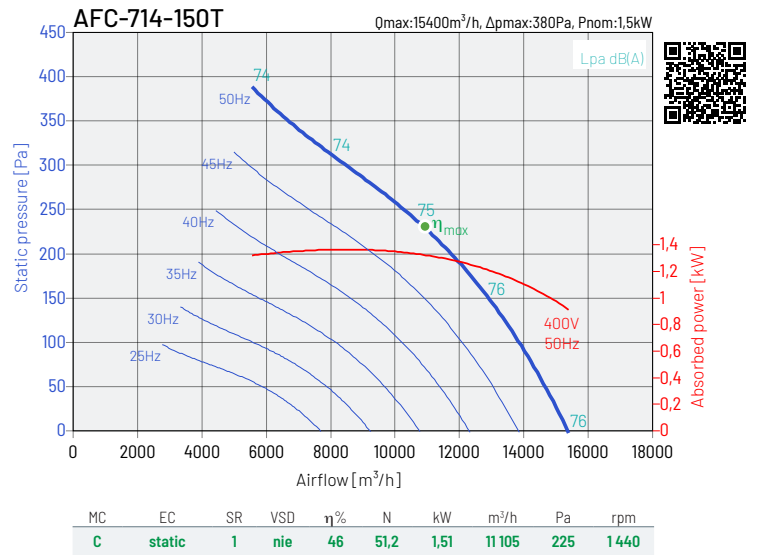
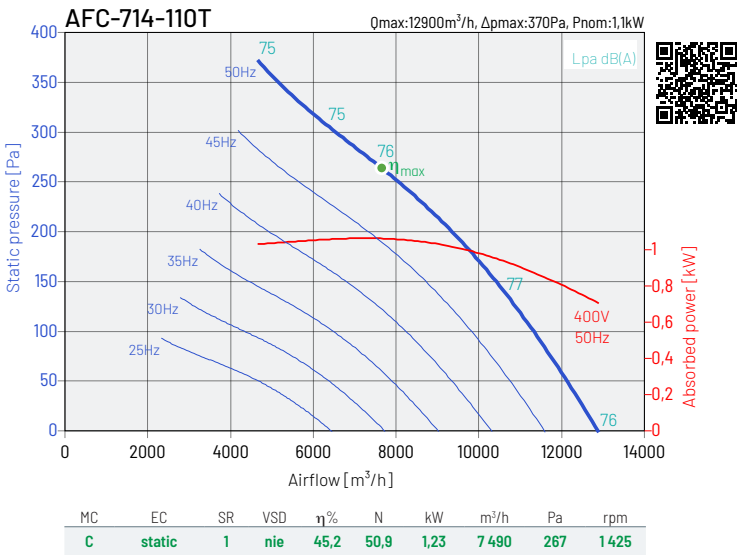
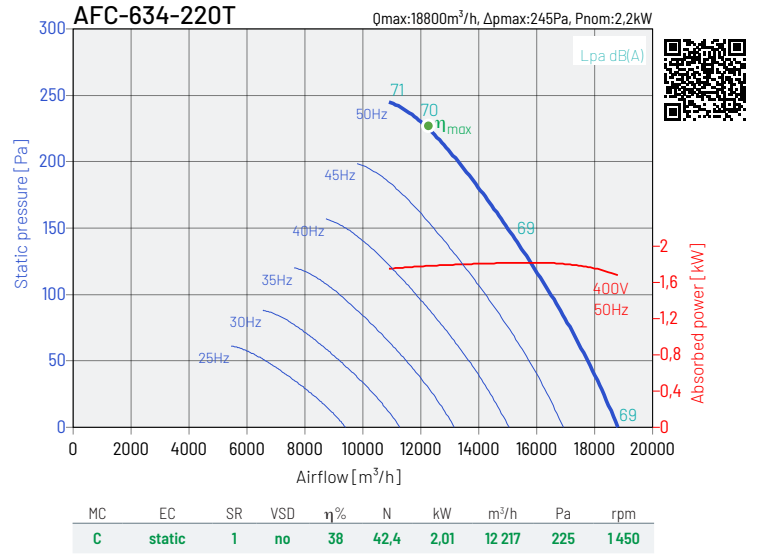
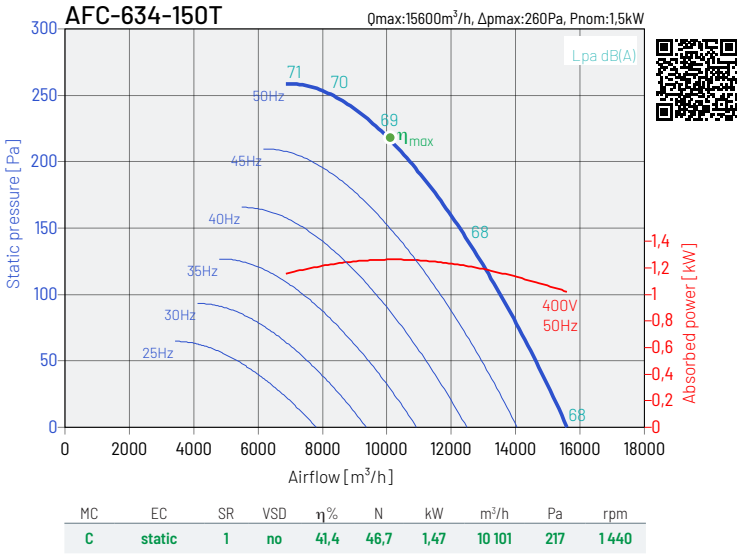

The performance characteristics of the fans are determined for a medium with a temperature of 20°C and atmospheric pressure of 1013.25hPa. Sound pressure level dB(A), determined at a distance of 1,5 m
Ecoproject: MC-Measurement category, EC-Efficiency category, VSD-Speed control: supplied with the fan, SR-Specific ratio, η%-Efficiency, N-Efficiency grade, kW-Absorbed power, m³/h-Airflow, Pa-Static pressure, RPM-Speed



PERFORMANCE CHARACTERISTICS OF THE FANS

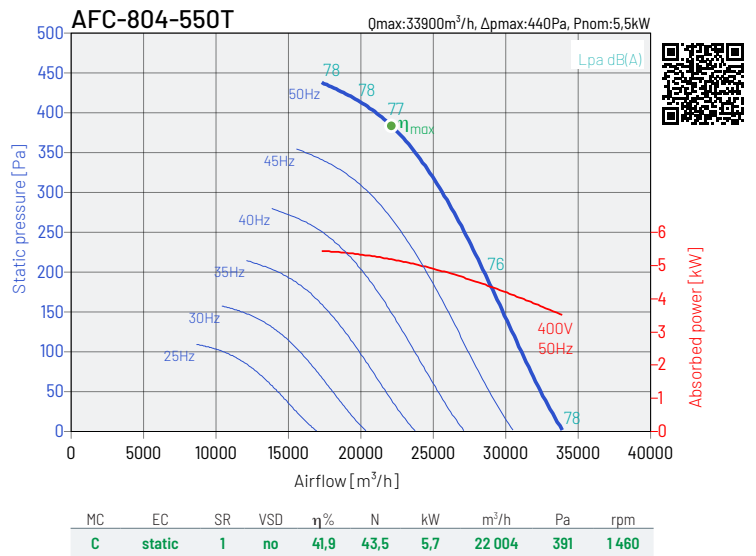
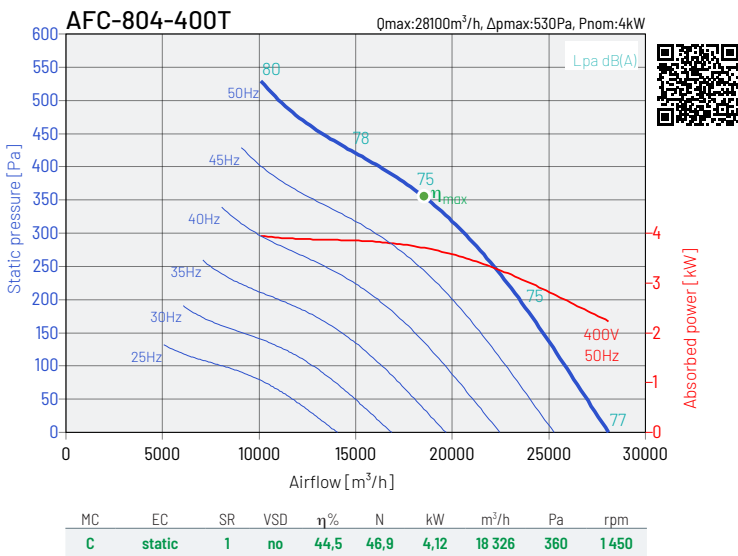
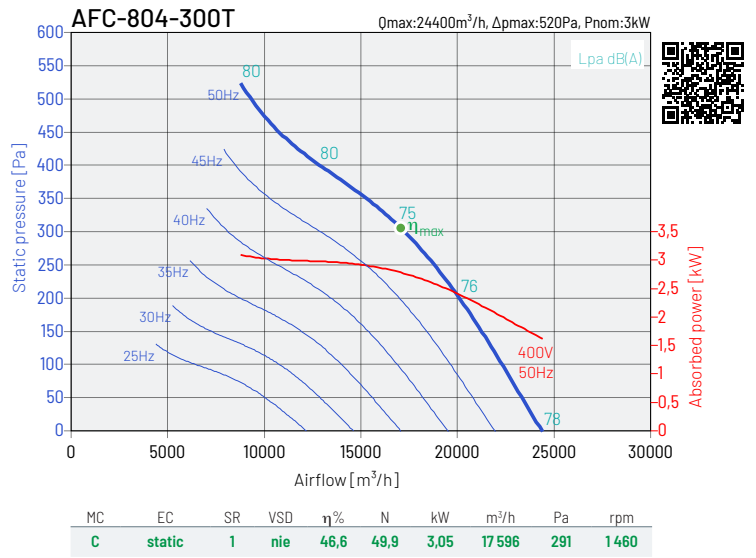
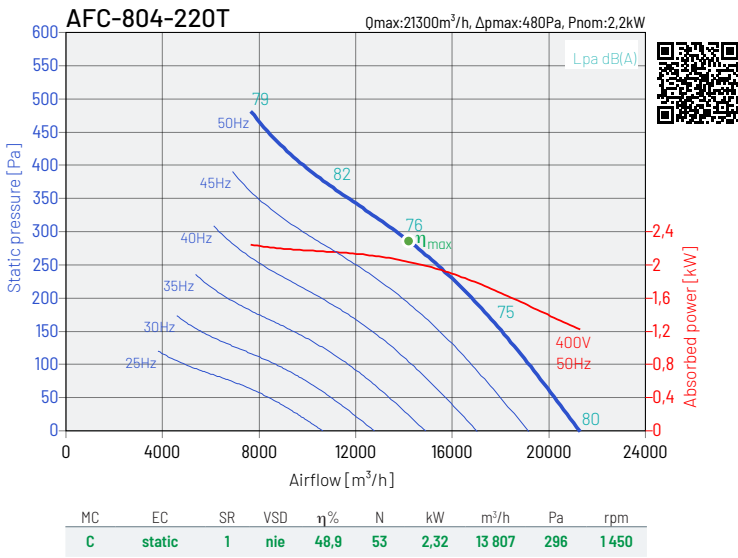
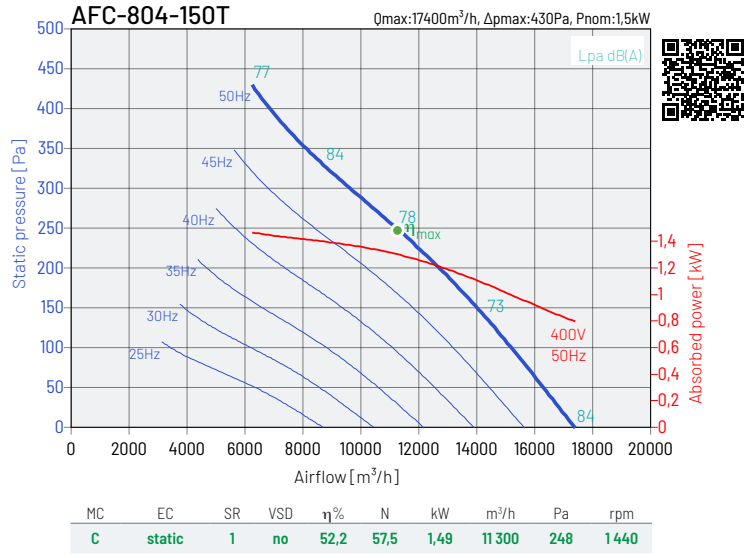
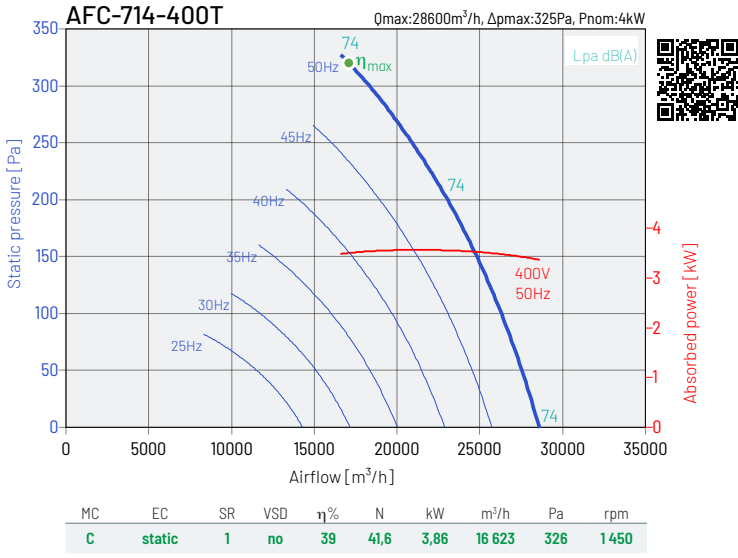

The performance characteristics of the fans are determined for a medium with a temperature of 20°C and atmospheric pressure of 1013.25hPa. Sound pressure level dB(A), determined at a distance of 1,5 m
Ecoproject: MC-Measurement category, EC-Efficiency category, VSD-Speed control: supplied with the fan, SR-Specific ratio, η%-Efficiency, N-Efficiency grade, kW-Absorbed power, m³/h-Airflow, Pa-Static pressure, RPM-Speed



PERFORMANCE CHARACTERISTICS OF THE FANS

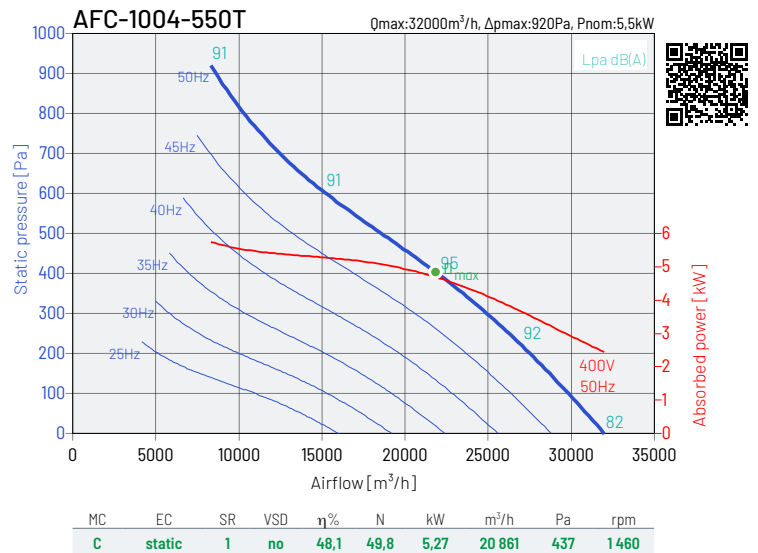
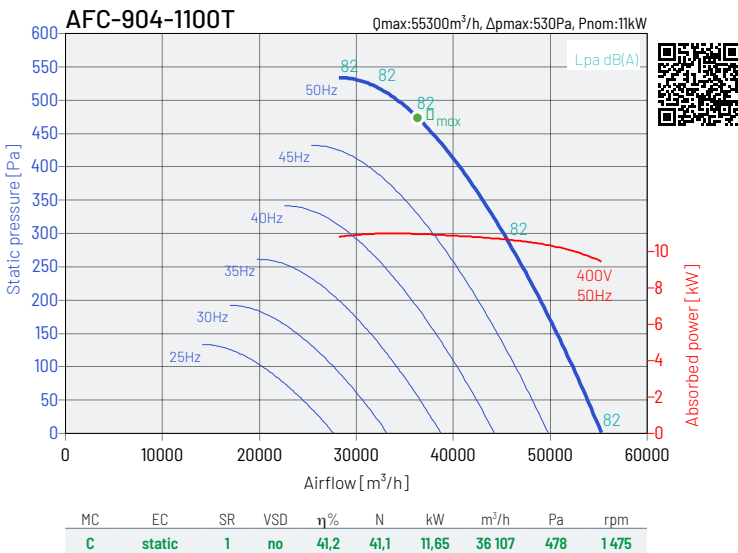
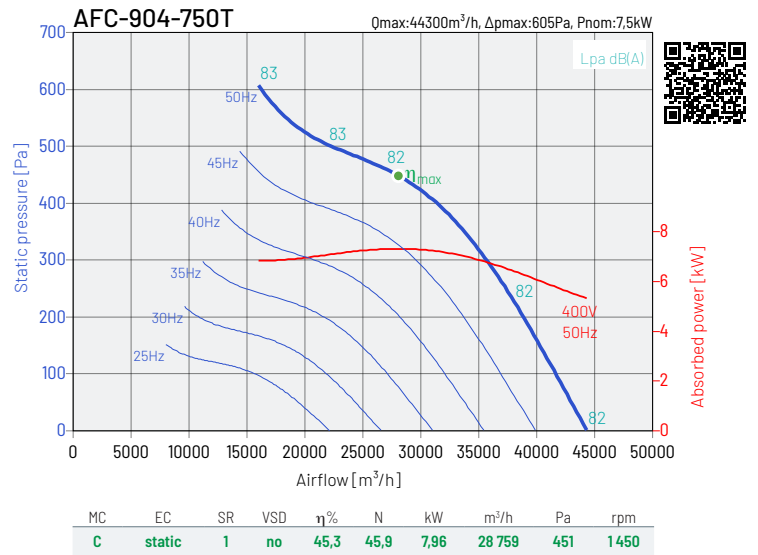
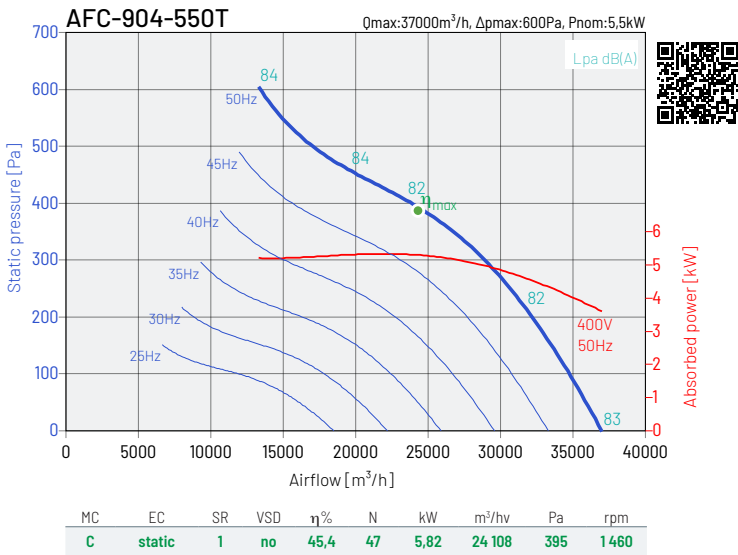
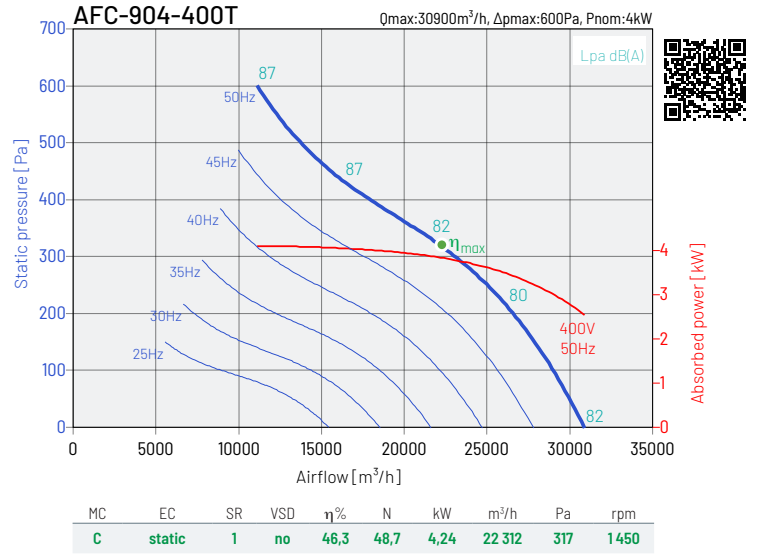
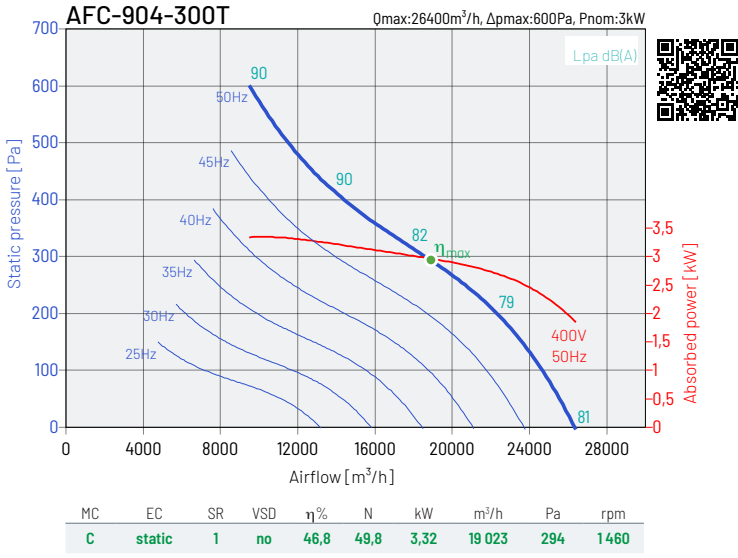

The performance characteristics of the fans are determined for a medium with a temperature of 20°C and atmospheric pressure of 1013.25hPa. Sound pressure level dB(A), determined at a distance of 1,5 m
Ecoproject: MC-Measurement category, EC-Efficiency category, VSD-Speed control: supplied with the fan, SR-Specific ratio, η%-Efficiency, N-Efficiency grade, kW-Absorbed power, m³/h-Airflow, Pa-Static pressure, RPM-Speed



PERFORMANCE CHARACTERISTICS OF THE FANS

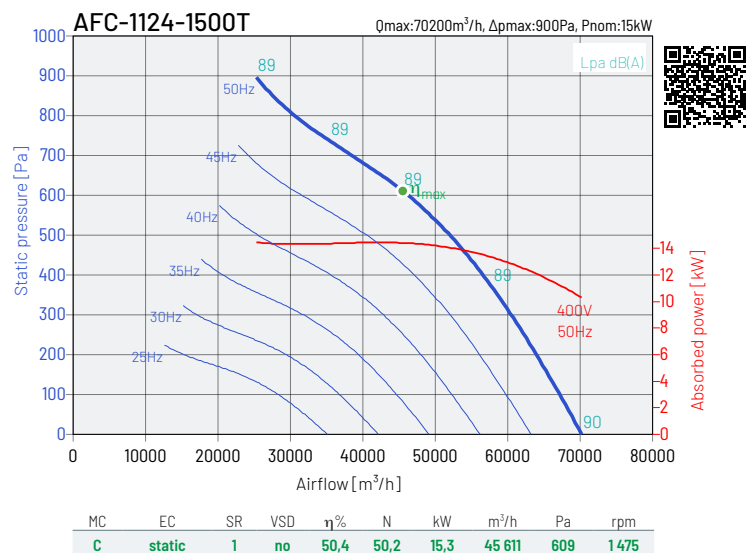
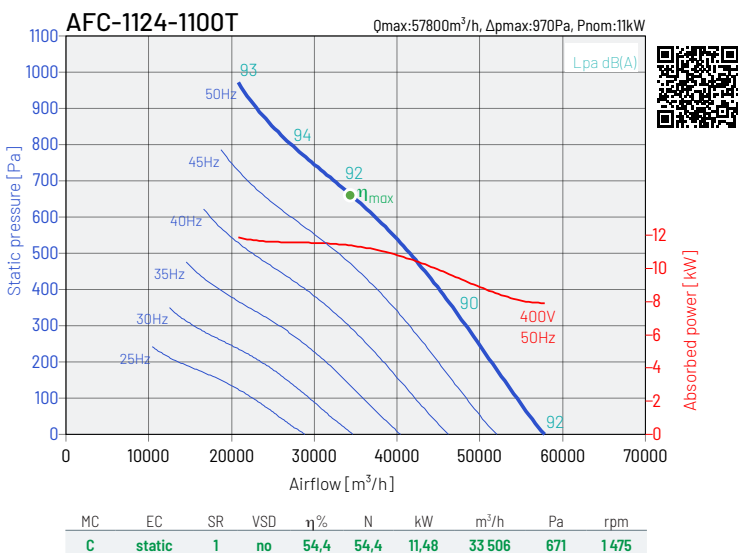
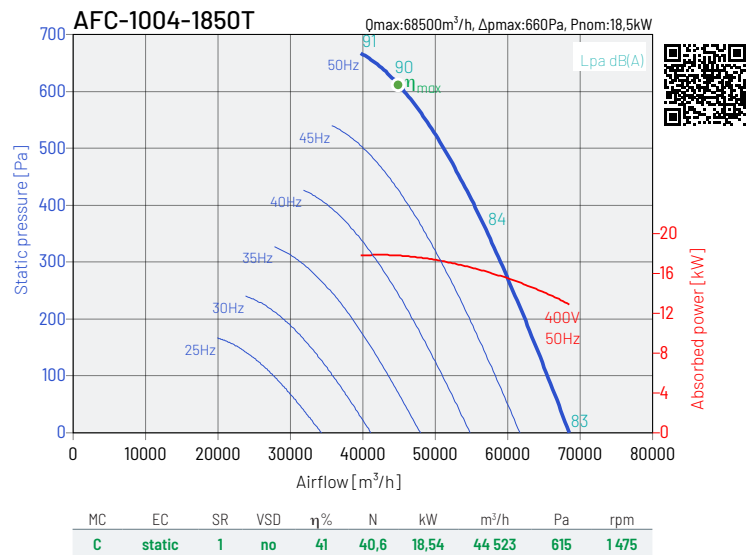
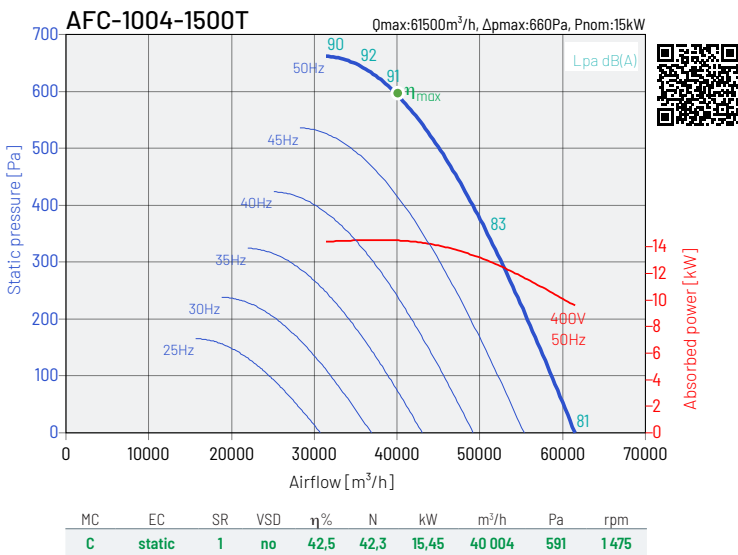
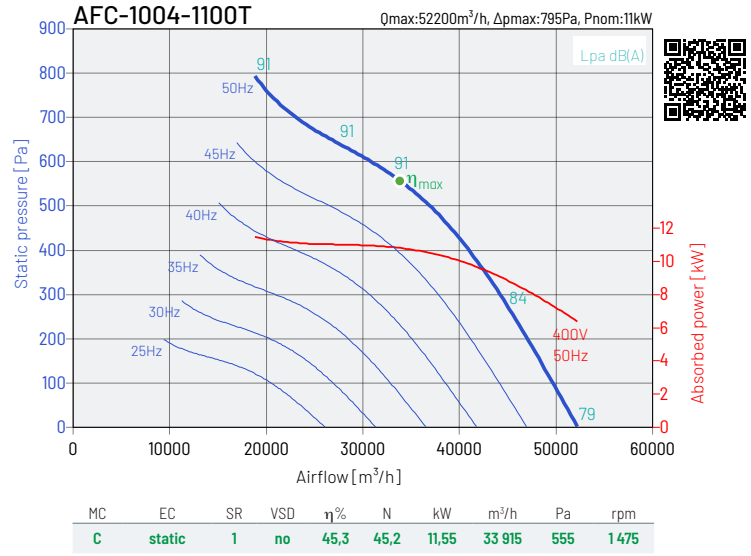
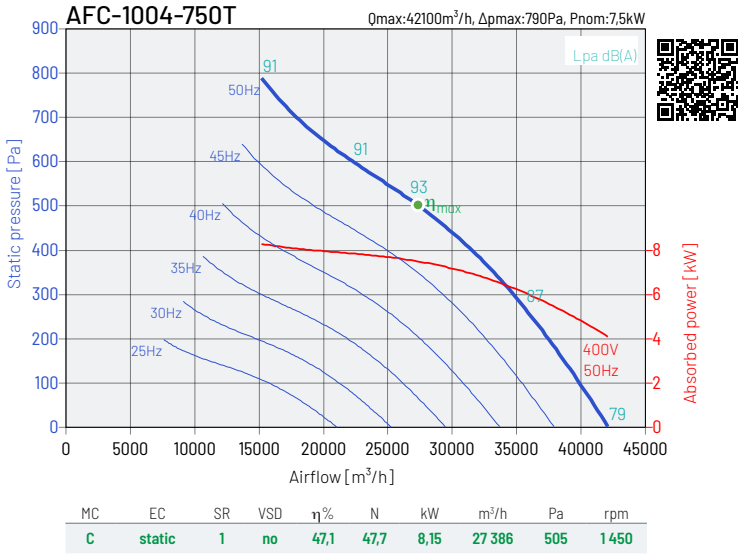

The performance characteristics of the fans are determined for a medium with a temperature of 20°C and atmospheric pressure of 1013.25hPa. Sound pressure level dB(A), determined at a distance of 1,5 m
Ecoproject: MC-Measurement category, EC-Efficiency category, VSD-Speed control: supplied with the fan, SR-Specific ratio, η%-Efficiency, N-Efficiency grade, kW-Absorbed power, m³/h-Airflow, Pa-Static pressure, RPM-Speed



PERFORMANCE CHARACTERISTICS OF THE FANS

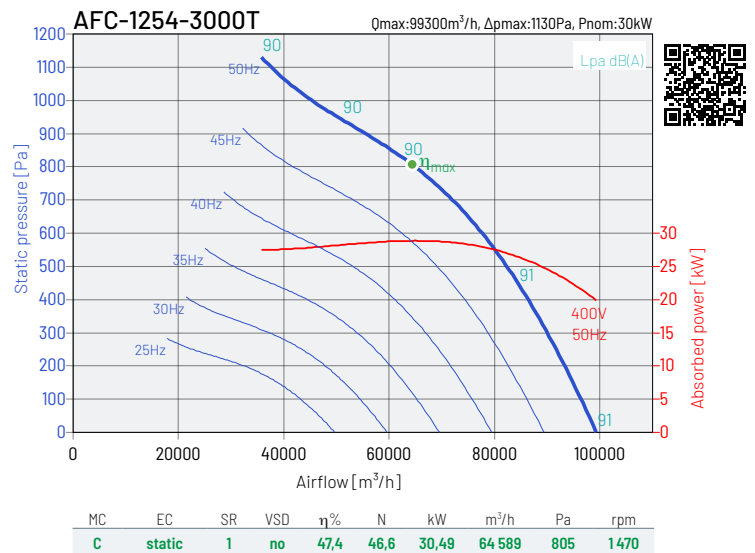
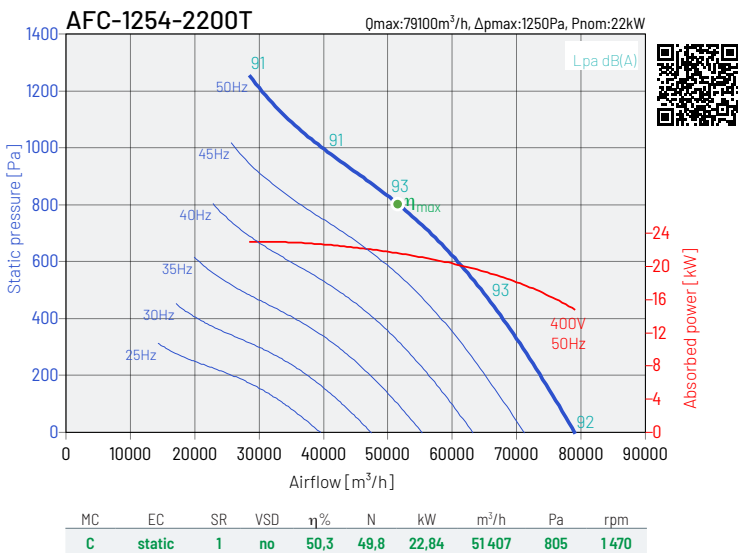
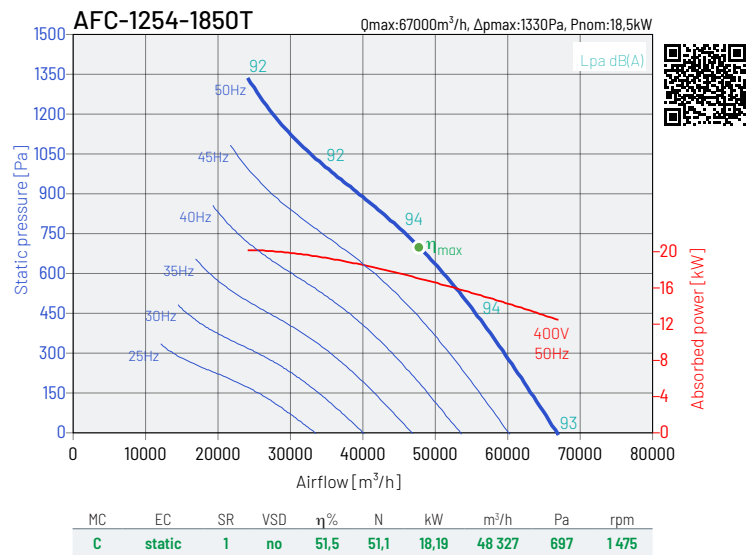
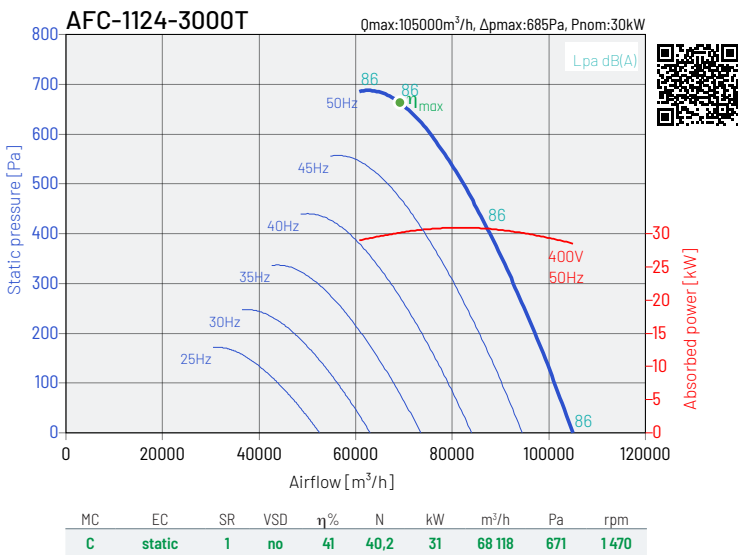
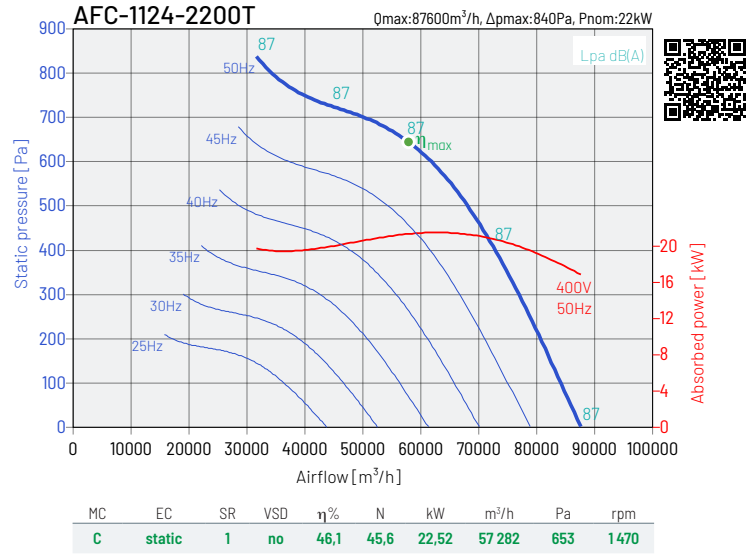
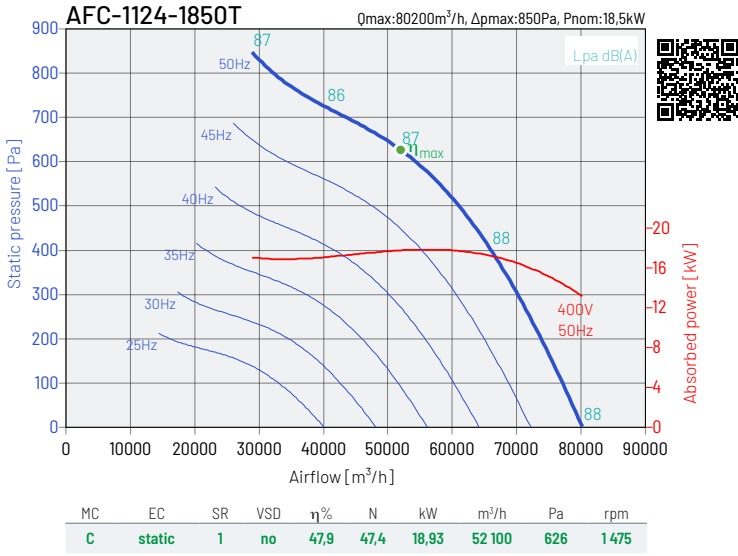

The performance characteristics of the fans are determined for a medium with a temperature of 20°C and atmospheric pressure of 1013.25hPa. Sound pressure level dB(A), determined at a distance of 1,5 m
Ecoproject: MC-Measurement category, EC-Efficiency category, VSD-Speed control: supplied with the fan, SR-Specific ratio, η%-Efficiency, N-Efficiency grade, kW-Absorbed power, m³/h-Airflow, Pa-Static pressure, RPM-Speed



PERFORMANCE CHARACTERISTICS OF THE FANS

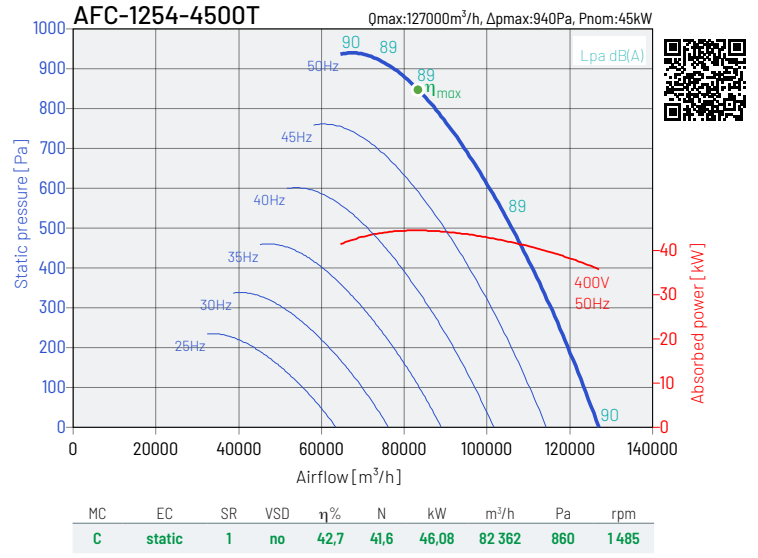
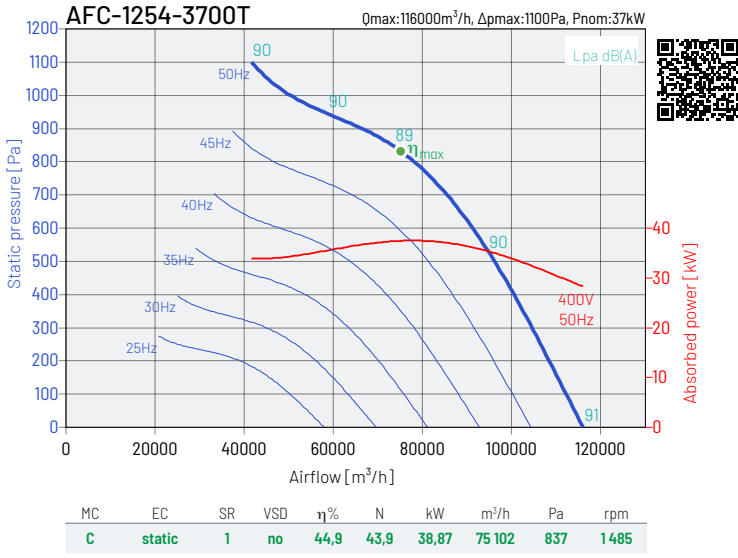

The performance characteristics of the fans are determined for a medium with a temperature of 20°C and atmospheric pressure of 1013.25hPa. Sound pressure level dB(A), determined at a distance of 1,5 m
Ecoproject: MC-Measurement category, EC-Efficiency category, VSD-Speed control: supplied with the fan, SR-Specific ratio, η%-Efficiency, N-Efficiency grade, kW-Absorbed power, m³/h-Airflow, Pa-Static pressure, RPM-Speed



DIMENSIONS

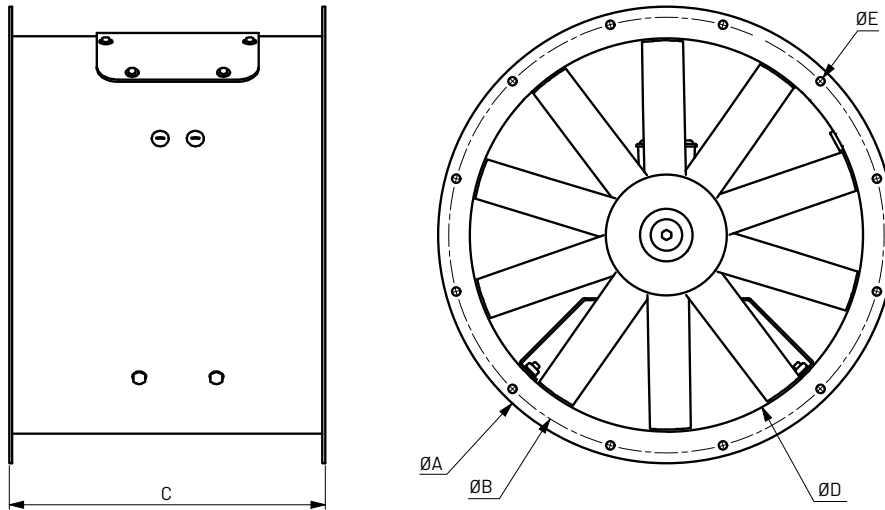

type	ØA mm	ØB mm	ØC mm	ØD mm	ØE mm	N holes
AFC-402-075S	480	450	390	400	12	8
AFC-402-110S	480	450	390	400	12	8
AFC-402-075T	480	450	390	400	12	8
AFC-402-110T	480	450	390	400	12	8
AFC-402-150T	480	450	410	400	12	8
AFC-402-220T	480	450	410	400	12	8
AFC-402-300T	480	450	410	400	12	8
AFC-452-110S	530	500	430	450	12	8
AFC-452-110T	530	500	430	450	12	8
AFC-452-150T	530	500	430	450	12	8
AFC-452-220T	530	500	430	450	12	8
AFC-452-300T	530	500	430	450	12	8
AFC-452-400T	530	500	480	450	12	8
AFC-502-220T	590	560	450	500	12	12
AFC-502-300T	590	560	450	500	12	12
AFC-502-400T	590	560	520	500	12	12
AFC-502-550T	590	560	520	500	12	12
AFC-502-750T	590	560	520	500	12	12
AFC-562-300T	650	620	450	560	12	12
AFC-562-400T	650	620	580	560	12	12
AFC-562-550T	650	620	580	560	12	12
AFC-562-750T	650	620	580	560	12	12
AFC-562-1100T	650	620	580	560	12	12
AFC-564-037T	650	620	450	560	12	12
AFC-564-055T	650	620	450	560	12	12
AFC-564-075T	650	620	450	560	12	12
AFC-564-110T	650	620	450	560	12	12
AFC-564-150T	650	620	450	560	12	12
AFC-632-400T	720	690	540	630	12	12
AFC-632-550T	720	690	540	630	12	12
AFC-632-750T	720	690	540	630	12	12
AFC-632-1100T	720	690	630	630	12	12
AFC-632-1500T	720	690	740	630	12	12
AFC-634-055T	720	690	470	630	12	12
AFC-634-075T	720	690	470	630	12	12

type	ØA mm	ØB mm	ØC mm	ØD mm	ØE mm	N holes
AFC-634-110T	720	690	470	630	12	12
AFC-634-150T	720	690	470	630	12	12
AFC-634-220T	720	690	540	630	12	12
AFC-714-110T	800	770	470	710	12	16
AFC-714-150T	800	770	470	710	12	16
AFC-714-220T	800	770	570	710	12	16
AFC-714-300T	800	770	570	710	12	16
AFC-714-400T	800	770	570	710	12	16
AFC-804-150T	890	860	500	800	12	16
AFC-804-220T	890	860	620	800	12	16
AFC-804-300T	890	860	620	800	12	16
AFC-804-400T	890	860	620	800	12	16
AFC-804-550T	890	860	620	800	12	16
AFC-904-300T	1005	970	600	900	15	16
AFC-904-400T	1005	970	600	900	15	16
AFC-904-550T	1005	970	750	900	15	16
AFC-904-750T	1005	970	750	900	15	16
AFC-904-1100T	1005	970	750	900	15	16
AFC-1004-550T	1105	1070	650	1000	15	16
AFC-1004-750T	1105	1070	650	1000	15	16
AFC-1004-1100T	1105	1070	810	1000	15	16
AFC-1004-1500T	1105	1070	810	1000	15	16
AFC-1004-1850T	1105	1070	810	1000	15	16
AFC-1124-1100T	1260	1190	810	1120	15	20
AFC-1124-1500T	1260	1190	810	1120	15	20
AFC-1124-1850T	1260	1190	810	1120	15	20
AFC-1124-2200T	1260	1190	810	1120	15	20
AFC-1124-3000T	1260	1190	1000	1120	15	20
AFC-1254-1850T	1390	1320	810	1250	15	20
AFC-1254-2200T	1390	1320	810	1250	15	20
AFC-1254-3000T	1390	1320	1100	1250	15	20
AFC-1254-3700T	1390	1320	1100	1250	15	20
AFC-1254-4500T	1390	1320	1100	1250	15	20



MOUNTING ACCESSORIES

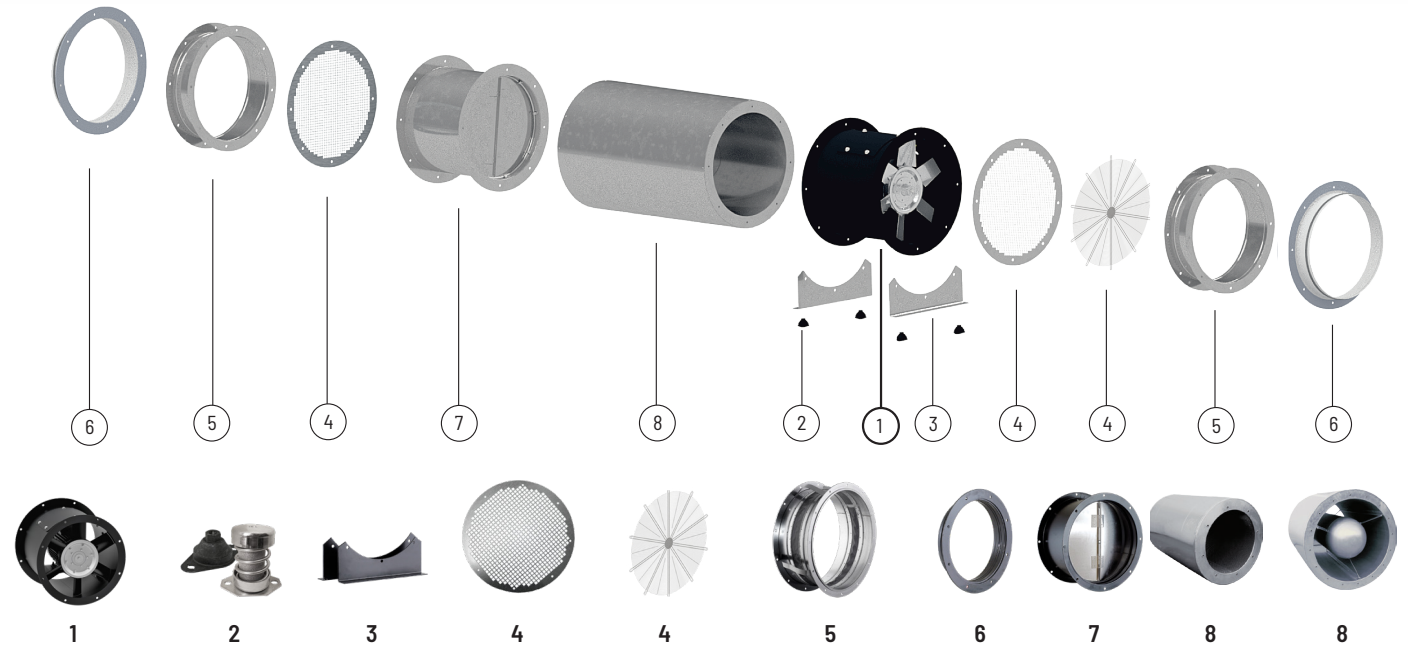

fan	vibroisolator	mounting feet	protective guard	protective guard	flexible connector	connector	flap valve	silencer SIL-CZ	silencer SIL-CZO
AFC-402	AVM-20*	M. FEET DN 400	PG Ø400	PG Ø400	FLEXIBLE CONN. Ø400	C Ø400	FV Ø400	SIL-CZ 400	SIL-CZO 400
AFC-452	AVM-20*	M. FEET DN 450	PG Ø450	PG Ø450	FLEXIBLE CONN. Ø450	C Ø450	FV Ø450	SIL-CZ 450	SIL-CZO 450
AFC-502	AVM-35*	M. FEET DN 500	PG Ø500	PG Ø500	FLEXIBLE CONN. Ø500	C Ø500	FV Ø500	SIL-CZ 500	SIL-CZO 500
AFC-56x	AVM-35*	M. FEET DN 560	PG Ø560	PG Ø560	FLEXIBLE CONN. Ø560	C Ø560	FV Ø560	SIL-CZ 560	SIL-CZO 560
AFC-632	AM-50M*	M. FEET DN 630	PG Ø630	PG Ø630	FLEXIBLE CONN. Ø630	C Ø630	FV Ø630	SIL-CZ 630	SIL-CZO 630
AFC-634	AVM-35*	M. FEET DN 630	PG Ø630	PG Ø630	FLEXIBLE CONN. Ø630	C Ø630	FV Ø630	SIL-CZ 630	SIL-CZO 630
AFC-714	AVM-35*	M. FEET DN 710	PG Ø710	PG Ø710	FLEXIBLE CONN. Ø710	C Ø710	FV Ø710	SIL-CZ 710	SIL-CZO 710
AFC-804	AVM-35**	M. FEET DN 800	PG Ø800	PG Ø800	FLEXIBLE CONN. Ø800	C Ø800	FV Ø800	SIL-CZ 800	SIL-CZO 800
AFC-904-300T/750T	AVM-35**	M. FEET DN 900	PG Ø900	PG Ø900	FLEXIBLE CONN. Ø900	C Ø900	FV Ø900	SIL-CZ 900	SIL-CZO 900
AFC-904-1100T	AM-50M**	M. FEET DN 900	PG Ø900	PG Ø900	FLEXIBLE CONN. Ø900	C Ø900	FV Ø900	SIL-CZ 900	SIL-CZO 900
AFC-1004-550T/750T	AVM-35**	M. FEET DN 1000	PG Ø1000	PG Ø1000	FLEXIBLE CONN. Ø1000	C Ø1000	FV Ø1000	SIL-CZ 1000	SIL-CZO 1000
AFC-1004-1100T/1850T	AM-50M**	M. FEET DN 1000	PG Ø1000	PG Ø1000	FLEXIBLE CONN. Ø1000	C Ø1000	FV Ø1000	SIL-CZ 1000	SIL-CZO 1000
AFC-1124-1100T/2200T	AM-75M**	M. FEET DN 1120	PG Ø1120	PG Ø1120	FLEXIBLE CONN. Ø1120	C Ø1120	FV Ø1120	SIL-CZ 1120	SIL-CZO 1120
AFC-1124-3000T	AM-100M**	M. FEET DN 1120	PG Ø1120	PG Ø1120	FLEXIBLE CONN. Ø1120	C Ø1120	FV Ø1120	SIL-CZ 1120	SIL-CZO 1120
AFC-1254-1850T/2200T	AM-100M**	M. FEET DN 1250	PG Ø1250	PG Ø1250	FLEXIBLE CONN. Ø1250	C Ø1250	FV Ø1250	SIL-CZ 1250	SIL-CZO 1250
AFC-1254-3000T	AM-125M**	M. FEET DN 1250	PG Ø1250	PG Ø1250	FLEXIBLE CONN. Ø1250	C Ø1250	FV Ø1250	SIL-CZ 1250	SIL-CZO 1250
AFC-1254-3700T/4500T	AM-150M**	M. FEET DN 1250	PG Ø1250	PG Ø1250	FLEXIBLE CONN. Ø1250	C Ø1250	FV Ø1250	SIL-CZ 1250	SIL-CZO 1250

* 4pcs. to the fan ** 6pcs. to the fan

Article numbers

26040960 AVM-20	42518193 PG Ø800	42517213 C Ø1000	42519000-58 SIL-CZ 1250-1250	42519020-16 SIL-CZO 710-710
26040965 AVM-35	42518203 PG Ø900	42517223 C Ø1120	42519020-32 SIL-CZ 400-600	42519020-19 SIL-CZO 800-800
41021391 AM-50M	42518213 PG Ø1000	42517233 C Ø1250	42519020-35 SIL-CZ 450-675	42519020-22 SIL-CZO 900-900
41021392 AM-75M	42518253 PG Ø1120	42516513 FV Ø400	42519020-38 SIL-CZ 500-750	42519020-25 SIL-CZO 1000-1000
41021393 AM-100M	42518263 PG Ø1250	42516517 FV Ø450	42519020-41 SIL-CZ 560-840	42519000-65 SIL-CZO 1120-1120
41021394 AM-125M	42519530 FLEXIBLE CONN. Ø400	42516520 FV Ø500	42519020-44 SIL-CZ 630-945	42519000-28 SIL-CZO 1250-1250
41021395 AM-150M	42519543 FLEXIBLE CONN. Ø450	42516524 FV Ø560	42519020-47 SIL-CZ 710-1065	42519020-02 SIL-CZO 400-600
42516133 M. FEET DN 400	42519550 FLEXIBLE CONN. Ø500	42516528 FV Ø630	42519020-50 SIL-CZ 800-1200	42519020-05 SIL-CZO 450-675
42516143 M. FEET DN 450	42519560 FLEXIBLE CONN. Ø560	42516537 FV Ø710	42519020-53 SIL-CZ 900-1350	42519020-08 SIL-CZO 500-750
42516153 M. FEET DN 500	42519570 FLEXIBLE CONN. Ø630	42516545 FV Ø800	42519020-56 SIL-CZ 1000-1500	42519020-11 SIL-CZO 560-840
42516163 M. FEET DN 560	42519583 FLEXIBLE CONN. Ø710	42516549 FV Ø900	42519020-33 SIL-CZ 400-800	42519020-14 SIL-CZO 630-945
42516173 M. FEET DN 630	42519593 FLEXIBLE CONN. Ø800	42516557 FV Ø1000	42519020-36 SIL-CZ 450-900	42519020-17 SIL-CZO 710-1065
42516183 M. FEET DN 710	42519603 FLEXIBLE CONN. Ø900	42516563 FV Ø1120	42519020-39 SIL-CZ 500-1000	42519020-20 SIL-CZO 800-1200
42516193 M. FEET DN 800	42519613 FLEXIBLE CONN. Ø1000	42516567 FV Ø1250	42519020-42 SIL-CZ 560-1120	42519020-23 SIL-CZO 900-1350
42516203 M. FEET DN 900	42519623 FLEXIBLE CONN. Ø1120	42519020-31 SIL-CZ 400-400	42519020-45 SIL-CZ 630-1260	42519020-26 SIL-CZO 1000-1500
42516213 M. FEET DN 1000	42519633 FLEXIBLE CONN. Ø1250	42519020-34 SIL-CZ 450-450	42519020-48 SIL-CZ 710-1420	42519020-03 SIL-CZO 400-800
42516253 M. FEET DN 1120	42517130 C Ø400	42519020-37 SIL-CZ 500-500	42519020-51 SIL-CZ 800-1600	42519020-06 SIL-CZO 450-900
42516263 M. FEET DN 1250	42517143 C Ø450	42519020-40 SIL-CZ 560-560	42519020-54 SIL-CZ 900-1800	42519020-09 SIL-CZO 500-1000
42518130 PG Ø400	42517150 C Ø500	42519020-43 SIL-CZ 630-630	42519020-57 SIL-CZ 1000-2000	42519020-12 SIL-CZO 560-1120
42518143 PG Ø450	42517160 C Ø560	42519020-46 SIL-CZ 710-710	42519020-01 SIL-CZO 400-400	42519020-15 SIL-CZO 630-1260
42518150 PG Ø500	42517170 C Ø630	42519020-49 SIL-CZ 800-800	42519020-04 SIL-CZO 450-450	42519020-18 SIL-CZO 710-1420
42518160 PG Ø560	42517183 C Ø710	42519020-52 SIL-CZ 900-900	42519020-07 SIL-CZO 500-500	42519020-21 SIL-CZO 800-1600
42518170 PG Ø630	42517193 C Ø800	42519020-55 SIL-CZ 1000-1000	42519020-10 SIL-CZO 560-560	42519020-24 SIL-CZO 900-1800
42518183 PG Ø710	42517203 C Ø900	42519000-62 SIL-CZ 1120-1120	42519020-13 SIL-CZO 630-630	



ELECTRICAL ACCESSORIES - Single-phase motors



type	wall thermostat	duct thermostat	air quality sensor	humidistat	thyristor regulator	transformer regulator		2-speed transformer regulator	
	TS	TK-21	SQA	HIG-2	REB	RMB	RVS	SC2	SC2A
AFC-402-075S	TS	TK-21	SQA	HIG-2	REB-10	RMB-8	RVS-7	SC2-1-75L25	SC2A1-75L25
AFC-402-110S	TS	TK-21	SQA	HIG-2	REB-10	RMB-8	RVS-7	SC2-1-110L25	SC2A1-110L25
AFC-452-110S	TS	TK-21	SQA	HIG-2	REB-10	RMB-8	RVS-7	SC2-1-110L25	SC2A1-110L25

ELECTRICAL ACCESSORIES - Three-phase motors



wentylator	wall thermostat	duct thermostat	air quality sensor	humidistat	inverter
	TS	TK-21	SQA	HIG-2	L
AFC-402-075T	TS + DILM7	TK-21+ DILM7	SQA + DILM7	HIG-2 + DILM7	L 0.75kW
AFC-402-110T	TS + DILM7	TK-21 + DILM7	SQA + DILM7	HIG-2 + DILM7	L 1.5kW
AFC-402-150T	TS + DILM7	TK-21 + DILM7	SQA + DILM7	HIG-2 + DILM7	L 1.5kW
AFC-402-220T	TS + DILM7	TK-21 + DILM7	SQA + DILM7	HIG-2 + DILM7	L 2.2kW
AFC-402-300T	TS + DILM7	TK-21 + DILM7	SQA + DILM7	HIG-2 + DILM7	L 4.0kW
AFC-452-110T	TS + DILM7	TK-21 + DILM7	SQA + DILM7	HIG-2 + DILM7	L 1.5kW
AFC-452-150T	TS + DILM7	TK-21 + DILM7	SQA + DILM7	HIG-2 + DILM7	L 1.5kW
AFC-452-220T	TS + DILM7	TK-21 + DILM7	SQA + DILM7	HIG-2 + DILM7	L 2.2kW
AFC-452-300T	TS + DILM7	TK-21 + DILM7	SQA + DILM7	HIG-2 + DILM7	L 4.0kW
AFC-452-400T	TS + DILM9	TK-21 + DILM9	SQA + DILM9	HIG-2 + DILM9	L 4.0kW
AFC-502-220T	TS + DILM7	TK-21 + DILM7	SQA + DILM7	HIG-2 + DILM7	L 2.2kW
AFC-502-300T	TS + DILM7	TK-21 + DILM7	SQA + DILM7	HIG-2 + DILM7	L 4.0kW
AFC-502-400T	TS + DILM9	TK-21 + DILM9	SQA + DILM9	HIG-2 + DILM9	L 4.0kW
AFC-502-550T	TS + DILM12	TK-21 + DILM12	SQA + DILM12	HIG-2 + DILM12	L 5.5kW
AFC-502-750T	TS + DILM15	TK-21 + DILM15	SQA + DILM15	HIG-2 + DILM15	L 7.5kW
AFC-562-300T	TS + DILM7	TK-21 + DILM7	SQA + DILM7	HIG-2 + DILM7	L 4.0kW
AFC-562-400T	TS + DILM9	TK-21 + DILM9	SQA + DILM9	HIG-2 + DILM9	L 4.0kW
AFC-562-550T	TS + DILM12	TK-21 + DILM12	SQA + DILM12	HIG-2 + DILM12	L 5.5kW
AFC-562-750T	TS + DILM15	TK-21 + DILM15	SQA + DILM15	HIG-2 + DILM15	L 7.5kW
AFC-562-1100T	TS + DILM25	TK-21 + DILM25	SQA + DILM25	HIG-2 + DILM25	L 11.0kW
AFC-564-037T	TS + DILM7	TK-21 + DILM7	SQA + DILM7	HIG-2 + DILM7	L 0.4kW
AFC-564-055T	TS + DILM7	TK-21 + DILM7	SQA + DILM7	HIG-2 + DILM7	L 0.75kW
AFC-564-075T	TS + DILM7	TK-21 + DILM7	SQA + DILM7	HIG-2 + DILM7	L 0.75kW
AFC-564-110T	TS + DILM7	TK-21 + DILM7	SQA + DILM7	HIG-2 + DILM7	L 1.5kW
AFC-564-150T	TS + DILM7	TK-21 + DILM7	SQA + DILM7	HIG-2 + DILM7	L 1.5kW
AFC-632-400T	TS + DILM9	TK-21 + DILM9	SQA + DILM9	HIG-2 + DILM9	L 4.0kW
AFC-632-550T	TS + DILM12	TK-21 + DILM12	SQA + DILM12	HIG-2 + DILM12	L 5.5kW
AFC-632-750T	TS + DILM15	TK-21 + DILM15	SQA + DILM15	HIG-2 + DILM15	L 7.5kW
AFC-632-1100T	TS + DILM25	TK-21 + DILM25	SQA + DILM25	HIG-2 + DILM25	L 11.0kW
AFC-632-1500T	TS + DILM32	TK-21 + DILM32	SQA + DILM32	HIG-2 + DILM32	L 0.4kW
AFC-634-055T	TS + DILM7	TK-21 + DILM7	SQA + DILM7	HIG-2 + DILM7	L 0.75kW



ELECTRICAL ACCESSORIES - Three-phase motors



wentylator	wall thermostat	duct thermostat	air quality sensor	humidistat	inverter
	TS	TK-21	SQA	HIG-2	L
AFC-634-075T	TS + DILM7	TK-21 + DILM7	SQA + DILM7	HIG-2 + DILM7	L 0.75kW
AFC-634-110T	TS + DILM7	TK-21 + DILM7	SQA + DILM7	HIG-2 + DILM7	L 1.5kW
AFC-634-150T	TS + DILM7	TK-21 + DILM7	SQA + DILM7	HIG-2 + DILM7	L 1.5kW
AFC-634-220T	TS + DILM7	TK-21 + DILM7	SQA + DILM7	HIG-2 + DILM7	L 2.2kW
AFC-714-110T	TS + DILM7	TK-21 + DILM7	SQA + DILM7	HIG-2 + DILM7	L 1.5kW
AFC-714-150T	TS + DILM7	TK-21 + DILM7	SQA + DILM7	HIG-2 + DILM7	L 1.5kW
AFC-714-220T	TS + DILM7	TK-21 + DILM7	SQA + DILM7	HIG-2 + DILM7	L 2.2kW
AFC-714-300T	TS + DILM7	TK-21 + DILM7	SQA + DILM7	HIG-2 + DILM7	L 4.0kW
AFC-714-400T	TS + DILM9	TK-21 + DILM9	SQA + DILM9	HIG-2 + DILM9	L 4.0kW
AFC-804-150T	TS + DILM7	TK-21 + DILM7	SQA + DILM7	HIG-2 + DILM7	L 1.5kW
AFC-804-220T	TS + DILM7	TK-21 + DILM7	SQA + DILM7	HIG-2 + DILM7	L 2.2kW
AFC-804-300T	TS + DILM7	TK-21 + DILM7	SQA + DILM7	HIG-2 + DILM7	L 4.0kW
AFC-804-400T	TS + DILM9	TK-21 + DILM9	SQA + DILM9	HIG-2 + DILM9	L 4.0kW
AFC-804-550T	TS + DILM12	TK-21 + DILM12	SQA + DILM12	HIG-2 + DILM12	L 5.5kW
AFC-904-300T	TS + DILM7	TK-21 + DILM7	SQA + DILM7	HIG-2 + DILM7	L 4.0kW
AFC-904-400T	TS + DILM9	TK-21 + DILM9	SQA + DILM9	HIG-2 + DILM9	L 4.0kW
AFC-904-550T	TS + DILM12	TK-21 + DILM12	SQA + DILM12	HIG-2 + DILM12	L 5.5kW
AFC-904-750T	TS + DILM15	TK-21 + DILM15	SQA + DILM15	HIG-2 + DILM15	L 7.5kW
AFC-904-1100T	TS + DILM25	TK-21 + DILM25	SQA + DILM25	HIG-2 + DILM25	L 11.0kW
AFC-1004-550T	TS + DILM12	TK-21 + DILM12	SQA + DILM12	HIG-2 + DILM12	L 5.5kW
AFC-1004-750T	TS + DILM15	TK-21 + DILM15	SQA + DILM15	HIG-2 + DILM15	L 7.5kW
AFC-1004-1100T	TS + DILM25	TK-21 + DILM25	SQA + DILM25	HIG-2 + DILM25	L 11.0kW
AFC-1004-1500T	TS + DILM32	TK-21 + DILM32	SQA + DILM32	HIG-2 + DILM32	L 15.0kW
AFC-1004-1850T	TS + DILM40	TK-21 + DILM40	SQA + DILM40	HIG-2 + DILM40	L 18.5kW
AFC-1124-1100T	TS + DILM25	TK-21 + DILM25	SQA + DILM25	HIG-2 + DILM25	L 11.0kW
AFC-1124-1500T	TS + DILM32	TK-21 + DILM32	SQA + DILM32	HIG-2 + DILM32	L 15.0kW
AFC-1124-1850T	TS + DILM40	TK-21 + DILM40	SQA + DILM40	HIG-2 + DILM40	L 18.5kW
AFC-1124-2200T	TS + DILM50	TK-21 + DILM50	SQA + DILM50	HIG-2 + DILM50	L 22.0kW
AFC-1124-3000T	TS + DILM65	TK-21 + DILM65	SQA + DILM65	HIG-2 + DILM65	L 30.0kW
AFC-1254-1850T	TS + DILM40	TK-21 + DILM40	SQA + DILM40	HIG-2 + DILM40	L 18.5kW
AFC-1254-2200T	TS + DILM50	TK-21 + DILM50	SQA + DILM50	HIG-2 + DILM50	L 22.0kW
AFC-1254-3000T	TS + DILM65	TK-21 + DILM65	SQA + DILM65	HIG-2 + DILM65	L 30.0kW
AFC-1254-3700T	TS + DILM80	TK-21 + DILM80	SQA + DILM80	HIG-2 + DILM80	L 37.0kW
AFC-1254-4500T	TS + DILM95	TK-21 + DILM95	SQA + DILM95	HIG-2 + DILM95	L 45.0kW

Article numbers

40025345 TS
40025320 TK-21
40025140 SQA
40025150 HIG-2

40025055 REB-10
40025080 RMB-8
40025236 RVS-7

40025258 SC2-1-75L25
40025260 SC2-1-110L25
40025259 SC2A1-75L25
40025261 SC2A1-110L25

40016302 L 0.4kW
40016312 L 0.75kW
40016322 L 1.5kW
40016332 L 2.2kW
40016352 L 4.0kW
40016362 L 5.5kW
40016372 L 7.5kW
40016383 L 11.0kW
40016392 L 15.0kW
40016412 L 18.5kW
40016422 L 22.0kW
* L 30.0kW
* L 37.0kW
* L 45.0kW

91040997 DILM7
91040666-40 DILM9
91040666-41 DILM12
91040666-42 DILM15
91040905 DILM25
91040666-44 DILM32
91040666-45 DILM40
91040666-46 DILM50
* DILM65
* DILM80
* DILM95
* on request